

CATÁLOGO 7  
VERSIÓN DIGITAL 4.1

7

illux

illux

illux

illux

illux

®

®

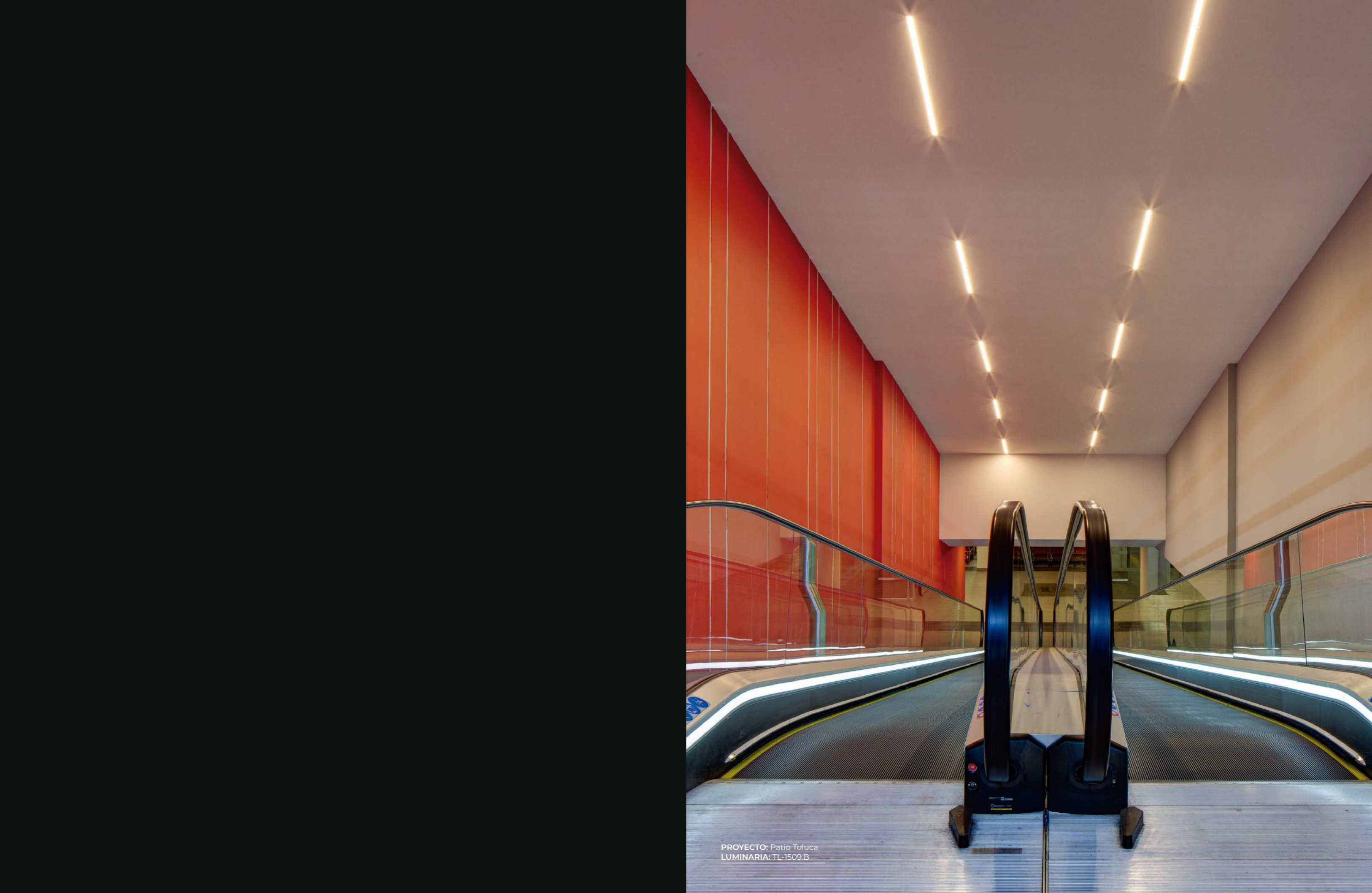

PROYECTO: Patio Toluca  
LUMINARIA: TL-1509.B

# Índice general

## Interior

			Páginas	
Techo	Empotrar	LED	<b>8 - 14</b>	
		Sin LED integrado	<b>15 - 32</b>	
	Riel		<b>34 - 35</b>	
	Sobreponer	LED	<b>38 - 51</b>	
		Sin LED integrado	<b>52 - 53</b>	
	Suspender	LED	<b>54 - 59</b>	
	Lineales	SUPER-LINE	LED	<b>62 - 63</b>
		MEGA-LINE	LED	<b>64 - 65</b>
		ULTRA-LINE	LED	<b>66 - 68</b>
		PRO-LINE	LED	<b>70 - 73</b>
	FLUORESCENTE		<b>74 - 77</b>	
Herméticos	LED	<b>78 - 80</b>		
	FLUORESCENTES	<b>81</b>		
Industriales	LED	<b>82 - 85</b>		
Muro	Empotrar	LED	<b>86 - 89</b>	
	Sobreponer	LED	<b>90 - 97</b>	
Emergencia	LED	<b>98 - 99</b>		
Ventilación		<b>100 - 101</b>		
Sensores		<b>102 - 107</b>		
Lámparas		<b>108 - 111</b>		

## Exterior

			Páginas
Piso	Empotrar	LED	<b>114 - 115</b>
	Sobreponer	LED	<b>118 - 125</b>
Muro	Empotrar	LED	<b>126 - 127</b>
	Sobreponer	LED	<b>128 - 135</b>
Urbano Vial	LED	<b>136 - 139</b>	
Marca Kartell		<b>140 - 147</b>	

## Glosario de Símbolos

**148 - 149**

## Índice de Códigos

**150 - 155**

# INTERIOR

-  Atenuable
-  Dirigible
-  Sensor integrado
-  Soporta humedad
-  Soporta polvo y agua
- LED** Tecnología LED
-  Luminaria para costa

\* Nuestros productos cuentan con certificación **NOM**.

\* Las medidas de los esquemas están en mm.

PROYECTO: Torre Reforma Latino  
LUMINARIA: TL-1513.B

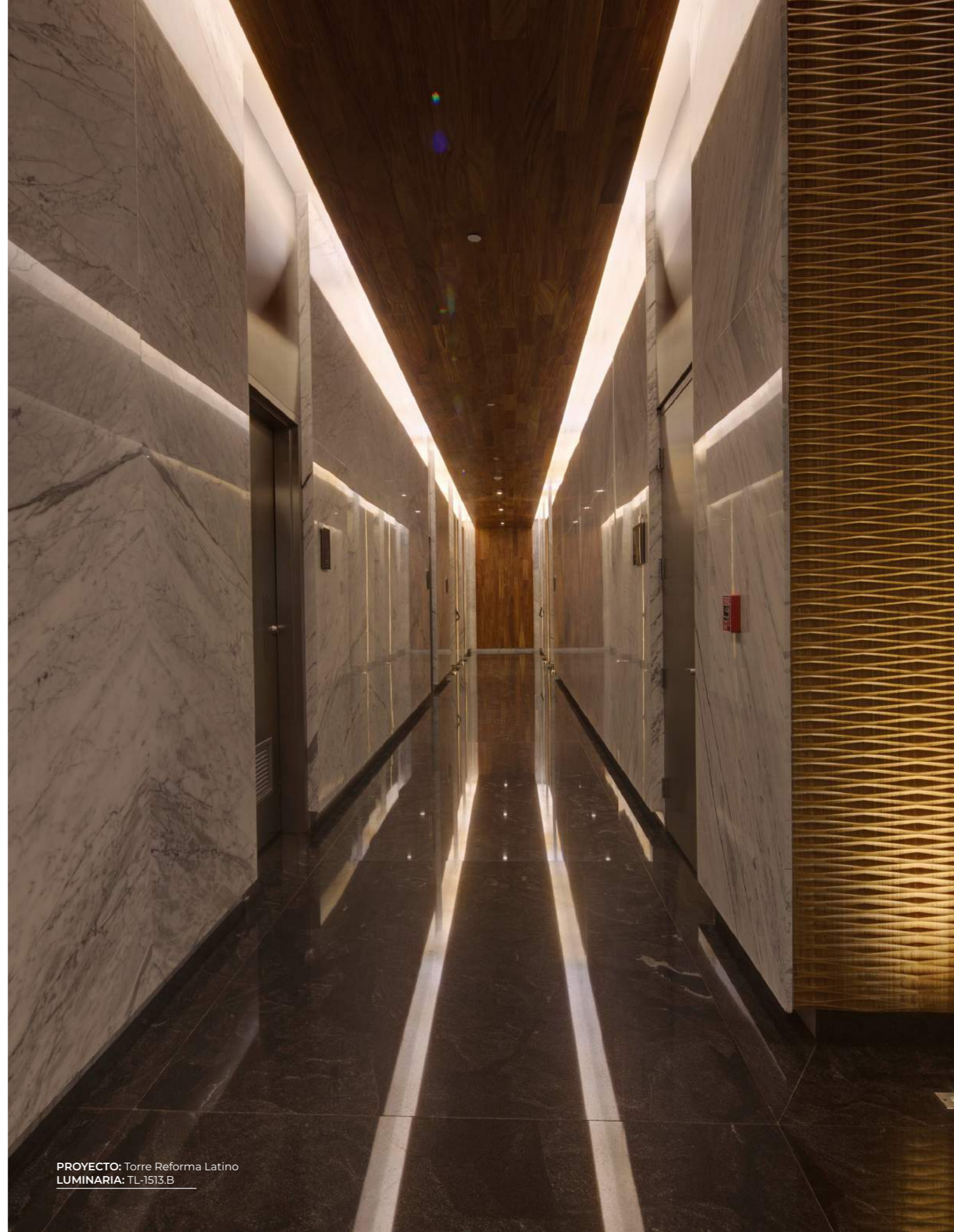

# LUMINARIOS DE INTERIOR PARA EMPOTRAR EN TECHO |



PROYECTO: Casa bosques de las lomas  
LUMINARIA: TL-4444.B

Interior / Techo / Empotrar / LED

## Luminarios Downlight LED Integrado |

Fabricados en aluminio



LED

### TL-4443.B30 BLANCO

SMD LED 2835  
6 W 100 - 277 V~ FP 0,9  
3 000 K 500 lm IRC >85  
IP 44 30 000 h Pza. caj. 50

### TL-4443.B40 BLANCO

SMD LED 2835  
6 W 100 - 277 V~ FP 0,9  
4 000 K 550 lm IRC >85  
IP 44 30 000 h Pza. caj. 50

LED

### TL-4444.B30 BLANCO

SMD LED 2835  
10 W 100 - 277 V~ FP 0,9  
3 000 K 810 lm IRC >85  
IP 44 30 000 h Pza. caj. 20

### TL-4444.B40 BLANCO

SMD LED 2835  
10 W 100 - 277 V~ FP 0,9  
4 000 K 810 lm IRC >85  
IP 44 30 000 h Pza. caj. 20



LED

### TL-4445.B30 BLANCO

SMD LED 2835  
20 W 100 - 277 V~ FP 0,9  
3 000 K 1 698 lm IRC >85  
IP 44 30 000 h Pza. caj. 25

### TL-4445.B40 BLANCO

SMD LED 2835  
20 W 100 - 277 V~ FP 0,9  
4 000 K 1 698 lm IRC >85  
IP 44 30 000 h Pza. caj. 25

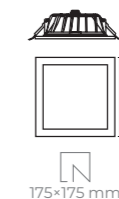

- \* Driver remoto.
- \* Disponibles con batería de emergencia.
- \* Permiten el uso con sensor de movimiento SE-2101.B o SE-2102.B (Pág. 103).

Interior / Techo / Empotrar / LED

## Luminarios Downlight LED Integrado |

Fabricados en plástico

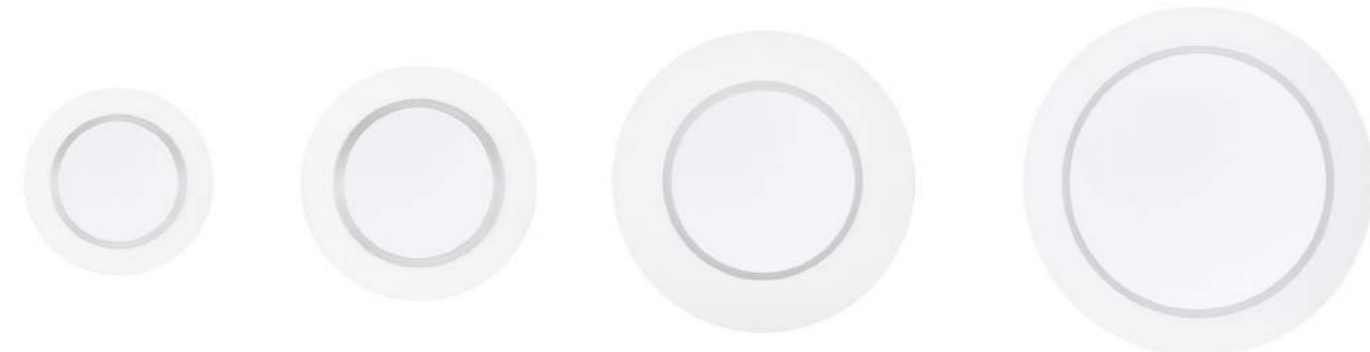

TL-6005

TL-6008

TL-6011

TL-6016

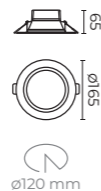

LED

### TL-6011.B30 BLANCO

LED  
10 W 100 - 277 V~ FP 0.9  
3 000 K 750 lm IRC >80  
IP 44 20 000 h Pza. caj. 30

### TL-6011.B30DIM BLANCO

LED  
10 W 110 - 130 V~ FP 0.9  
3 000 K 750 lm IRC >80  
IP 44 20 000 h Pza. caj. 30

### TL-6011.B40 BLANCO

LED  
10 W 100 - 277 V~ FP 0.9  
4 000 K 850 lm IRC >80  
IP 44 20 000 h Pza. caj. 30

### TL-6011.B65 BLANCO

LED  
10 W 100 - 277 V~ FP 0.9  
6 500 K 850 lm IRC >80  
IP 44 20 000 h Pza. caj. 30

ACCESORIOS PARA MODELO TL-6011.B (INCLUIDOS)

• PINZAS PARA BOTE INTEGRAL 80 mm.  
Material acero.

• PINZAS PARA PLAFÓN  
Material plástico



TL-6011

\* Driver integrado.

\* Permiten el uso con sensor de movimiento SE-2101.B o SE-2102.B (Pág. 103).

Interior / Techo / Empotrar / LED

## Luminarios Downlight LED Integrado |

Fabricados en plástico



TL-6024

TL-6035

TL-1009

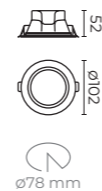

LED

### TL-6005.B30 BLANCO

LED  
5 W 100 - 277 V~ FP 0.9  
3 000 K 380 lm IRC >80  
IP 44 20 000 h Pza. caj. 100

### TL-6005.B40 BLANCO

LED  
5 W 100 - 277 V~ FP 0.9  
4 000 K 400 lm IRC >80  
IP 44 20 000 h Pza. caj. 100

### TL-6005.B60 BLANCO

LED  
5 W 100 - 277 V~ FP 0.9  
6 000 K 430 lm IRC >80  
IP 44 20 000 h Pza. caj. 100

LED

### TL-6008.B30 BLANCO

LED  
8 W 100 - 277 V~ FP 0.9  
3 000 K 630 lm IRC >80  
IP 44 20 000 h Pza. caj. 60

### TL-6008.B40 BLANCO

LED  
8 W 100 - 277 V~ FP 0.9  
4 000 K 680 lm IRC >80  
IP 44 20 000 h Pza. caj. 60

### TL-6008.B60 BLANCO

LED  
8 W 100 - 277 V~ FP 0.9  
6 000 K 700 lm IRC >80  
IP 44 20 000 h Pza. caj. 60



TL-6005  
TL-6008

\* Driver integrado.

\* Permiten el uso con sensor de movimiento SE-2101.B o SE-2102.B (Pág. 103).

## Luminarios Downlight LED Integrado |

Fabricados en plástico

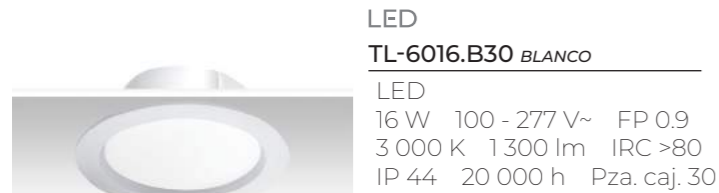

**LED**  
**TL-6016.B30 BLANCO**  
LED  
16 W 100 - 277 V~ FP 0.9  
3 000 K 1 300 lm IRC >80  
IP 44 20 000 h Pza. caj. 30



**LED**  
**TL-6024.B30 BLANCO**  
LED  
24 W 100 - 277 V~ FP 0.9  
3 000 K 2 000 lm IRC >80  
IP 44 20 000 h Pza. caj. 20

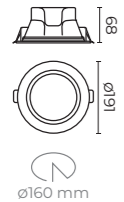

**TL-6016.B40 BLANCO**  
LED  
16 W 100 - 277 V~ FP 0.9  
4 000 K 1 400 lm IRC >80  
IP 44 20 000 h Pza. caj. 30

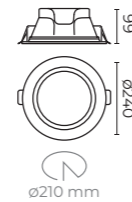

**TL-6024.B40 BLANCO**  
LED  
24 W 100 - 277 V~ FP 0.9  
4 000 K 2 200 lm IRC >80  
IP 44 20 000 h Pza. caj. 20

**TL-6016.B60 BLANCO**  
LED  
16 W 100 - 277 V~ FP 0.9  
6 000 K 1 450 lm IRC >80  
IP 44 20 000 h Pza. caj. 30

**TL-6024.B65 BLANCO**  
LED  
24 W 100 - 277 V~ FP 0.9  
6 500 K 2 300 lm IRC >80  
IP 44 20 000 h Pza. caj. 20

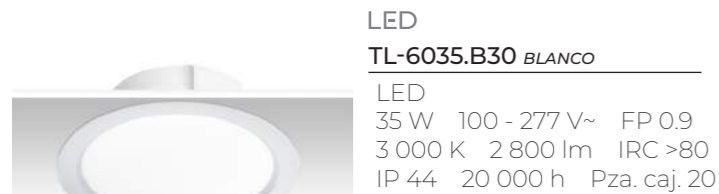

**LED**  
**TL-6035.B30 BLANCO**  
LED  
35 W 100 - 277 V~ FP 0.9  
3 000 K 2 800 lm IRC >80  
IP 44 20 000 h Pza. caj. 20

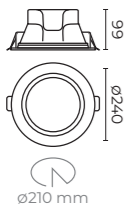

**TL-6035.B40 BLANCO**  
LED  
35 W 100 - 277 V~ FP 0.9  
4 000 K 3 000 lm IRC >80  
IP 44 20 000 h Pza. caj. 20



**LED**  
**TL-1009.B30 BLANCO**  
LED  
10 W 100 - 240 V~ FP 0.9  
3 000 K 650 lm IRC >80  
IP 30 25 000 h Pza. caj. 30

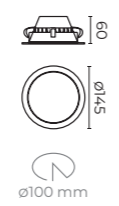

**TL-1009.B40 BLANCO**  
LED  
10 W 100 - 240 V~ FP 0.9  
4 000 K 650 lm IRC >80  
IP 30 25 000 h Pza. caj. 30

**TL-6035.B65 BLANCO**  
LED  
35 W 100 - 277 V~ FP 0.9  
6 500 K 3 150 lm IRC >80  
IP 44 20 000 h Pza. caj. 20

**TL-1009.B65 BLANCO**  
LED  
10 W 100 - 240 V~ FP 0.9  
6 500 K 650 lm IRC >80  
IP 30 25 000 h Pza. caj. 30

**ACCESORIOS PARA MODELO TL-1009.B (INCLUIDOS)**

• **PINZAS PARA BOTE INTEGRAL 80 mm.**  
Material acero.

• **PINZAS PARA PLAFÓN**  
Material plástico



TL-6016  
TL-6024  
TL-6035  
TL-1009

\* Driver integrado.  
\* Permiten el uso con sensor de movimiento SE-2101.B o SE-2102.B (Pág. 103).

## Luminarios Downlight LED Integrado |

Fabricados en aluminio



**LED**  
**TL-4340.B BLANCO**  
SMD LED  
9.6 W 100 - 240 V~ FP 0.9  
3 000 K 550 lm 36°  
IRC >85 IP 20  
25 000 h Pza. caj. 50



**LED**  $\nabla_{30^\circ}$   
**TL-4340.BD BLANCO**  
SMD LED  
9.6 W 100 - 240 V~ FP 0.9  
3 000 K 550 lm 36°  
IRC >85 IP 20  
25 000 h Pza. caj. 50

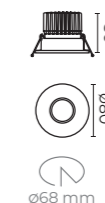

TL-4340

\* Driver remoto.  
\* Disponible con batería de emergencia.  
\* Permiten el uso con sensor de movimiento SE-2101.B o SE-2102.B (Pág. 103).

Interior / Techo / Empotrar / LED

## Luminarios Downlight LED Integrado |

Fabricados en polibutileno

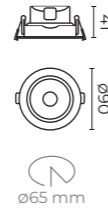

LED  $\nabla_{30^\circ}$

### TL-2901.B30 BLANCO

SMD LED  
5 W 100 - 240 V~ FP 0.5  
3 000 K 350 lm  
38° IRC >80 IP 20  
25 000 h Pza. caj. 50

\* Modelo dirigitble.

### TL-2901.B65 BLANCO

SMD LED  
5 W 100 - 240 V~ FP 0.5  
6 500 K 350 lm  
38° IRC >80 IP 20  
25 000 h Pza. caj. 50

\* Modelo dirigitble.



LED  $\nabla_{30^\circ}$

### TL-2902.B30 BLANCO

SMD LED  
5 W 100 - 240 V~ FP 0.5  
3 000 K 350 lm  
38° IRC >80 IP 20  
25 000 h Pza. caj. 50

\* Modelo dirigitble.

### TL-2902.B65 BLANCO

SMD LED  
5 W 100 - 240 V~ FP 0.5  
6 500 K 350 lm  
38° IRC >80 IP 20  
25 000 h Pza. caj. 50

\* Modelo dirigitble.



- \* Driver integrado.
- \* Permiten el uso con sensor de movimiento SE-2101.B o SE-2102.B (Pág. 103).

Interior / Techo / Empotrar / Sin LED integrado

## Luminarios Downlight |

Fabricados en aluminio



### TH-1226.B BLANCO - ACERO TH-1226.N NEGRO - NEGRO TH-1226.BB BLANCO - BLANCO

MR16 (No incluida)  
Base GU5.3  
50 W 12 V~ | 127 V~  
IP 20 Pza. caj. 50

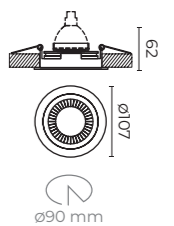

$\nabla_{15^\circ}$

### TH-1217.B BLANCO

MR16 (No incluida)  
Base GU5.3  
50 W 12 V~ | 127 V~  
IP 20 Pza. caj. 50

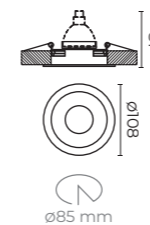

### TH-1217.BN BLANCO - NEGRO

MR16 (No incluida)  
Base GU5.3  
50 W 12 V~ | 127 V~  
IP 20 Pza. caj. 50



### TH-1218.B BLANCO

MR16 (No incluida)  
Base GU5.3  
50 W 12 V~ | 127 V~  
IP 20 Pza. caj. 50

MR16 (No incluida)  
Base GU5.3  
50 W 12 V~ | 127 V~  
IP 20 Pza. caj. 50

MR16 (No incluida)  
Base GU5.3  
50 W 12 V~ | 127 V~  
IP 20 Pza. caj. 50



- \* Con opción a transformador de 12 V~ para lámpara de halógeno.
- \* Permiten el uso con sensor de movimiento SE-2101.B o SE-2102.B (Pág. 103).
- \* Opción a soquet GU10 y lámpara GU10 LED atenuable FL-10GU10.527 de 2 700 K, FL-10GU10.530 de 3 000 K o FL-10GU10.565 de 6 500 K (Pág. 110).
- \* Sugerencia de lámpara FL-10MR16.530 de 3 000 K o FL-10MR16.540 de 4 000 K (Pág. 110).



Interior / Techo / Empotrar / Sin LED integrado

# Luminarios Downlight Antideslumbrante |

Fabricados en policarbonato



·TL-2903.B

·TL-2904.B



## TL-2903.B BLANCO

MR16 LED (No incluida)  
Base GU5.3  
50 W máx. 127 V~  
IP 20 Pza. caj. 50

## TL-2903.N NEGRO

MR16 LED (No incluida)  
Base GU5.3  
50 W máx. 127 V~  
IP 20 Pza. caj. 50



## TL-2904.B BLANCO

MR16 LED (No incluida)  
Base GU5.3  
50 W máx. 127 V~  
IP 20 Pza. caj. 50

\* Wall Washer.

## TL-2904.N NEGRO

MR16 LED (No incluida)  
Base GU5.3  
50 W máx. 127 V~  
IP 20 Pza. caj. 50

\* Wall Washer.

Interior / Techo / Empotrar / Sin LED integrado

# Luminarios Downlight Antideslumbrante |

Fabricados en policarbonato



·TL-2905.N

·TL-2906.N



## TL-2905.B BLANCO

MR16 LED (No incluida)  
Base GU5.3  
50 W máx. 127 V~  
IP 20 Pza. caj. 50

## TL-2905.N NEGRO

MR16 LED (No incluida)  
Base GU5.3  
50 W máx. 127 V~  
IP 20 Pza. caj. 50

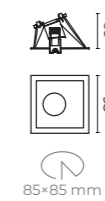
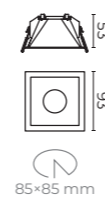

## TL-2906.B BLANCO

MR16 LED (No incluida)  
Base GU5.3  
50 W máx. 127 V~  
IP 20 Pza. caj. 50

\* Wall Washer.

## TL-2906.N NEGRO

MR16 LED (No incluida)  
Base GU5.3  
50 W máx. 127 V~  
IP 20 Pza. caj. 50

\* Wall Washer.



\* Sólo admiten uso de lámpara LED.  
\* Permiten el uso con sensor de movimiento SE-2101.B o SE-2102.B (Pág. 103).  
\* Sugerencia de lámpara FL-10MR16.530 de 3 000 K o FL-10MR16.540 de 4 000 K (Pág. 110).



\* Sólo admiten uso de lámpara LED.  
\* Permiten el uso con sensor de movimiento SE-2101.B o SE-2102.B (Pág. 103).  
\* Sugerencia de lámpara FL-10MR16.530 de 3 000 K o FL-10MR16.540 de 4 000 K (Pág. 110).

Interior / Techo / Empotrar / Sin LED integrado

## Luminarios Downlight Redondo |

Fabricados en policarbonato

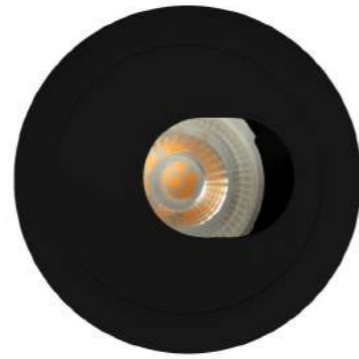

TL-2907.B

TL-2908.N



### TL-2907.B BLANCO

Lámpara MR16 LED  
No incluida  
Base GU5.3  
15 W máx.  
127 V~  
IP 20



### TL-2908.B BLANCO

Lámpara MR16 LED  
No incluida  
Base GU5.3  
15 W máx.  
127 V~  
IP 20

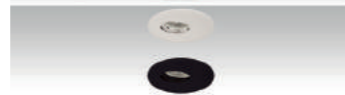

### TL-2907.N NEGRO

Lámpara MR16 LED  
No incluida  
Base GU5.3  
15 W máx.  
127 V~  
IP 20



ø mm



ø mm

### TL-2908.N NEGRO

Lámpara MR16 LED  
No incluida  
Base GU5.3  
15 W máx.  
127 V~  
IP 20

MONTAJE Y DIRECCIÓN DE LA LUZ



TL-2907  
TL-2908

\* Requiere driver para bajo voltaje.

\* Compatible únicamente con lámparas LED.

\* Sugerencia de lámpara FL-10MR16.530 de 3 000 K o FL-10MR16.540 de 4 000 K (Pág. 110).



Interior / Techo / Empotrar / Sin LED integrado

## Luminarios Downlight para áreas húmedas |

Fabricados en aluminio | fabricado en acero inoxidable



### TH-1216.B BLANCO

MR16 (No incluida)  
Base GU5.3  
50 W 12 V~ | 127 V~  
IP 44 Pza. caj. 50

\* Admite uso para fuente de poder TL-4008.C (Pág. 90.)  
\* Fabricado en aluminio.



### TH-4222.B BLANCO

MR16 (No incluida)  
Base GU5.3  
50 W 12 V~ | 127 V~  
IP 44 Pza. caj. 100

\* Fabricado en aluminio.



### TH-4245.A ACERO

MR16 (No incluida)  
Base GU5.3  
50 W 12 V~ | 127 V~  
IP 44 Pza. caj. 50

\* Fabricado en  
acero inoxidable.



MONTAJE Y  
DIRECCIÓN  
DE LA LUZ



TH-4245  
TH-4222  
TH-1216

- \* Ideal para uso en áreas húmedas.
- \* Con opción a transformador de 12 V~ para lámpara de halógeno.
- \* Permiten el uso con sensor de movimiento SE-2101.B o SE-2102.B (Pág. 103).
- \* Opción a soquet GU10 y lámpara GU10 LED atenuable FL-10GU10.527 de 2 700 K, FL-10GU10.530 de 3 000 K o FL-10GU10.565 de 6 500 K (Pág. 110).
- \* Sugerencia de lámpara FL-10MR16.530 de 3 000 K o FL-10MR16.540 de 4 000 K (Pág. 110).



PROYECTO: Lomas de Vista Hermosa  
LUMINARIA: TH-1216.B

Interior / Techo / Empotrar / Sin LED integrado

## Luminarios Downlight |

Fabricados en aluminio



### TH-1220.A ALUMINIO

MR16 (No incluida)  
Base GU5.3  
50 W 12 V~ | 127 V~  
IP 20 Pza. caj. 50

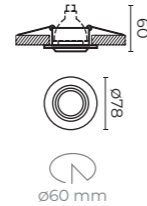

### TH-1221.A ALUMINIO

MR16 (No incluida)  
Base GU5.3  
50 W 12 V~ | 127 V~  
IP 20 Pza. caj. 100

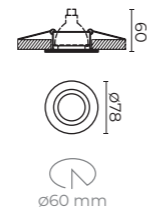

- \* Con opción a transformador de 12 V~ para lámpara de halógeno.
- \* Permiten el uso con sensor de movimiento SE-2101.B o SE-2102.B (Pág. 103).
- \* Opción a soquet GU10 y lámpara GU10 LED atenuable FL-10GU10.527 de 2 700 K, FL-10GU10.530 de 3 000 K o FL-10GU10.565 de 6 500 K (Pág. 110).
- \* Sugerencia de lámpara FL-10MR16.530 de 3 000 K o FL-10MR16.540 de 4 000 K (Pág. 110).

Interior / Techo / Empotrar / Sin LED integrado

## Luminarios Downlight |

Fabricados en aluminio



### TH-4219.B BLANCO TH-4219.S SATÍN

MR16 (No incluida)  
Base GU5.3  
50 W 12 V~ | 127 V~  
IP 20 Pza. caj. 50

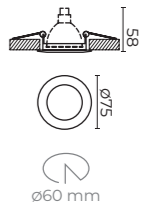
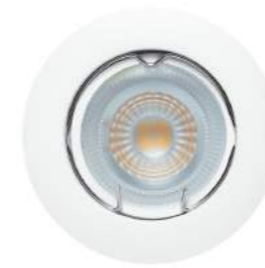

30°

### TH-4221.B BLANCO TH-4221.S SATÍN

MR16 (No incluida)  
Base GU5.3  
50 W 12 V~ | 127 V~  
IP 20 Pza. caj. 50

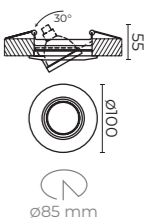
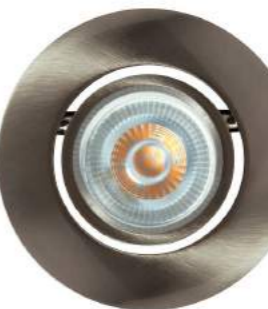

- \* Con opción a transformador de 12 V~ para lámpara de halógeno.
- \* Permiten el uso con sensor de movimiento SE-2101.B o SE-2102.B (Pág. 103).
- \* Opción a soquet GU10 y lámpara GU10 LED atenuable FL-10GU10.527 de 2 700 K, FL-10GU10.530 de 3 000 K o FL-10GU10.565 de 6 500 K (Pág. 110).
- \* Sugerencia de lámpara FL-10MR16.530 de 3 000 K o FL-10MR16.540 de 4 000 K (Pág. 110).

Interior / Techo / Empotrar / Sin LED integrado

## Luminarios Downlight |

Fabricado en aluminio

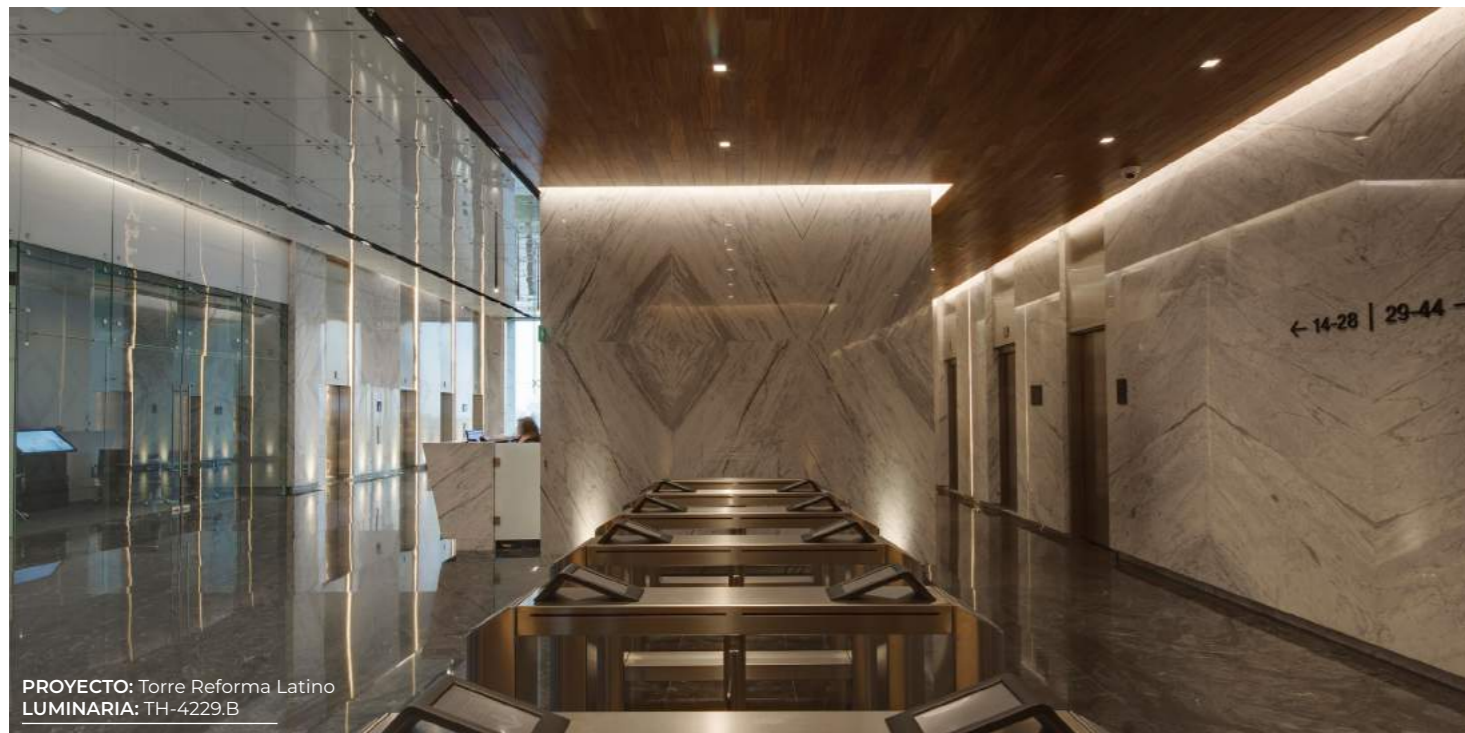

TH-4229.B BLANCO

MR16 (No incluida)  
Base GU5.3  
50 W 12 V~ | 127 V~  
IP 20 Pza. caj. 50

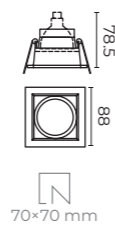

- \* Con opción a transformador de 12 V~ para lámpara de halógeno.
- \* Permiten el uso con sensor de movimiento SE-2101.B o SE-2102.B (Pág. 103).
- \* Compatible con fuente de poder TL-4008.G (Pág. 102).
- \* Opción a soquet GU10 y lámpara GU10 LED atenuable FL-10GU10.527 de 2 700 K, FL-10GU10.530 de 3 000 K o FL-10GU10.565 de 6 500 K (Pág. 110).
- \* Sugerencia de lámpara FL-10MR16.530 de 3 000 K o FL-10MR16.540 de 4 000 K (Pág. 110).

Interior / Techo / Empotrar / Sin LED integrado

## Luminarios Downlight |

Fabricados en aluminio



30°

TH-4251.A ALUMINIO

MR16 (No incluida)  
Base GU5.3  
50 W 12 V~ | 127 V~  
IP 20 Pza. caj. 100

\* Modelo dirigible.

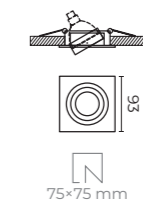

30°

TH-4252.A ALUMINIO

(2) MR16 (No incluidas)  
Base GU5.3  
2x50 W 12 V~ | 127 V~  
IP 20 Pza. caj. 18

\* Modelo dirigible.

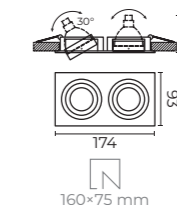

- \* Con opción a transformador de 12 V~ para lámpara de halógeno.
- \* Permiten el uso con sensor de movimiento SE-2101.B o SE-2102.B (Pág. 103).
- \* Compatible con fuente de poder TL-4008.G (Pág. 102).
- \* Opción a soquet GU10 y lámpara GU10 LED atenuable FL-10GU10.527 de 2 700 K, FL-10GU10.530 de 3 000 K o FL-10GU10.565 de 6 500 K (Pág. 110).
- \* Sugerencia de lámpara FL-10MR16.530 de 3 000 K o FL-10MR16.540 de 4 000 K (Pág. 110).

## Luminarios Downlight dirigibles |

Fabricados en aluminio



### TH-2212.B BLANCO

MR16 (No incluida)  
Base GU5.3  
50 W 12 V~ | 127 V~  
IP 20 Pza. caj. 24

\* Modelo dirijible.

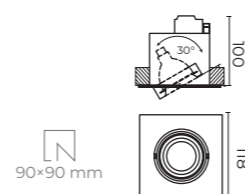

### TH-2213.B BLANCO

(2) MR16 (No incluidas)  
Base GU5.3  
2x50 W 12 V~ | 127 V~  
IP 20 Pza. caj. 16

\* Modelo dirijible.

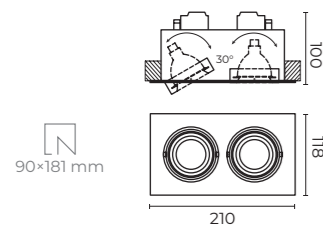

### TH-2214.B BLANCO

(3) MR16 (No incluidas)  
Base GU5.3  
3x50 W 12 V~ | 127 V~  
IP 20 Pza. caj. 16

\* Modelo dirijible.

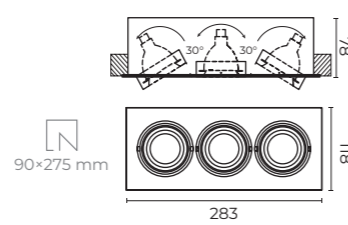

## Luminarios Downlight dirigibles |

Fabricados en aluminio



### TH-4230.N BLANCO TH-4230.NN NEGRO

MR16 (No incluida)  
Base GU5.3  
50 W 12 V~ | 127 V~  
IP 20 Pza. caj. 50

\* Modelo dirijible.

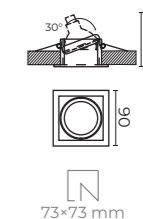

### TH-4231.N BLANCO TH-4231.NN NEGRO

(2) MR16 (No incluidas)  
Base GU5.3  
2x50 W 12 V~ | 127 V~  
IP 20 Pza. caj. 12

\* Modelo dirijible.

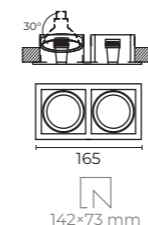

### TH-4232.N BLANCO TH-4232.NN NEGRO

(3) MR16 (No incluidas)  
Base GU5.3  
3x50 W 12 V~ | 127 V~  
IP 20 Pza. caj. 12

\* Modelo dirijible.

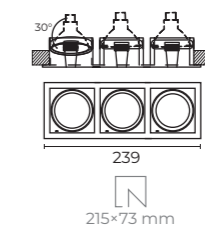

MONTAJE Y DIRECCIÓN DE LA LUZ



TH-2212  
TH-2213  
TH-2214

- \* Con opción a transformador de 12 V~ para lámpara de halógeno.
- \* Permiten el uso con sensor de movimiento SE-2101.B o SE-2102.B (Pág. 103).
- \* Opción a soquet GU10 y lámpara GU10 LED atenuable FL-10GU10.527 de 2 700 K, FL-10GU10.530 de 3 000 K o FL-10GU10.565 de 6 500 K (Pág. 110).
- \* Sugerencia de lámpara FL-10MR16.530 de 3 000 K o FL-10MR16.540 de 4 000 K (Pág. 110).

MONTAJE Y DIRECCIÓN DE LA LUZ



TH-4230  
TH-4231  
TH-4232

- \* Con opción a transformador de 12 V~ para lámpara de halógeno.
- \* Permiten el uso con sensor de movimiento SE-2101.B o SE-2102.B (Pág. 103).
- \* Compatible con fuente de poder TL-4008.G (Pág. 102).
- \* Opción a soquet GU10 y lámpara GU10 LED atenuable FL-10GU10.527 de 2 700 K, FL-10GU10.530 de 3 000 K o FL-10GU10.565 de 6 500 K (Pág. 110).
- \* Sugerencia de lámpara FL-10MR16.530 de 3 000 K o FL-10MR16.540 de 4 000 K (Pág. 110).

## Luminarios Downlight dirigibles |

Fabricados en aluminio



**TH-4240.B BLANCO**  
**TH-4240.N NEGRO**

MR16 (No incluida)  
Base GU5.3  
50 W 12 V~ | 127 V~  
IP 20 Pza. caj. 50

\* Modelo dirigible.

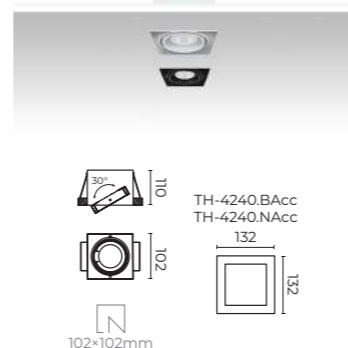

**TH-4241.B BLANCO**  
**TH-4241.N NEGRO**

(2) MR16 (No incluidas)  
Base GU5.3  
2x50 W 12 V~ | 127 V~  
IP 20 Pza. caj. 12

\* Modelo dirigible.

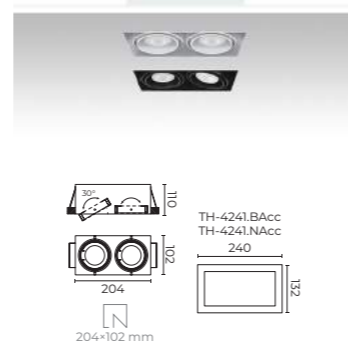

## Luminarios Downlight dirigibles |

Fabricados en aluminio



**TH-4202.B BLANCO**  
**TH-4202.N NEGRO**

AR111 (No incluida)  
Base C53  
50 W 12 V~ | 127 V~  
IP 20 Pza. caj. 12

\* Modelo dirigible.

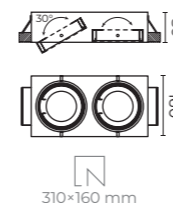
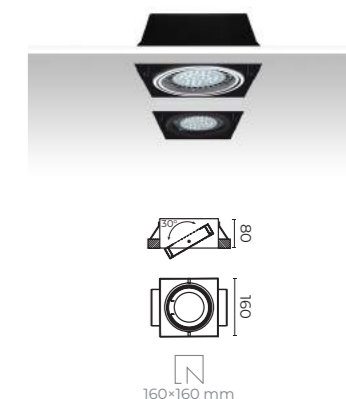

**TH-4203.B BLANCO**  
**TH-4203.N NEGRO**

(2) AR111 (No incluidas)  
Base C53  
2x50 W 12 V~ | 127 V~  
IP 20 Pza. caj. 8

\* Modelo dirigible.

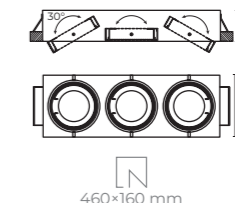

**TH-4204.B BLANCO**  
**TH-4204.N NEGRO**

(3) AR111 (No incluidas)  
Base C53  
3x50 W 12 V~ | 127 V~  
IP 20 Pza. caj. 6

\* Modelo dirigible.

ACCESORIOS PARA MODELO TH-4202 (NO INCLUIDOS)

- TH-4202.BAcc Marco color blanco.
- TH-4202.NAcc Marco color negro.



ACCESORIOS PARA MODELO TH-4203 (NO INCLUIDOS)

- TH-4203.BAcc Marco color blanco.
- TH-4203.NAcc Marco color negro.



ACCESORIOS PARA MODELO TH-4204 (NO INCLUIDOS)

- TH-4204.BAcc Marco color blanco.
- TH-4204.NAcc Marco color negro.



- \* Accesorios se venden por separado. No incluyen tornillos.
- \* Con opción a transformador de 12 V~ para lámpara de halógeno.
- \* Permiten el uso con sensor de movimiento SE-2101.B o SE-2102.B (Pág. 103).
- \* Opción a soquet GU10 y lámpara GU10 LED atenuable FL-10GU10.527 de 2 700 K, FL-10GU10.530 de 3 000 K o FL-10GU10.565 de 6 500 K (Pág. 110).
- \* Sugerencia de lámpara FL-10MR16.530 de 3 000 K o FL-10MR16.540 de 4 000 K (Pág. 110).
- \* Compatible con fuente de poder TL-4008.G (Pág. 110).



- \* Accesorios se venden por separado. No incluyen tornillos.
- \* Con opción a transformador de 12 V~ para lámpara de halógeno.
- \* Permiten el uso con sensor de movimiento SE-2101.B o SE-2102.B (Pág. 103).
- \* Compatible con fuente de poder TL-4115.G. (Pág. 110)

Interior / Techo / Empotrar / Sin LED integrado

## Luminarios Downlight dirigibles |

Fabricados en aluminio



·TH-4206.B

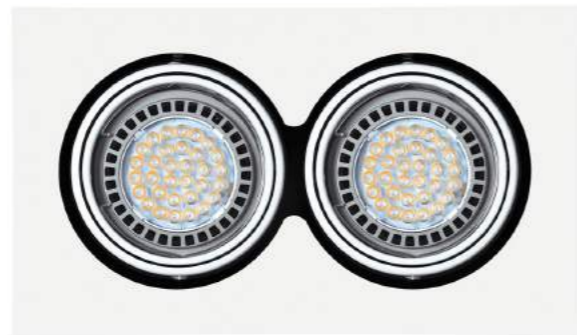

·TH-4207.B

∠<sub>30°</sub>

**TH-4206.B BLANCO**

AR111 (No incluida)  
Base G53  
50 W 12 V~ | 127 V~  
IP 20 Pza. caj. 12

\* Modelo dirigible.

∠<sub>30°</sub>

**TH-4207.B BLANCO**

(2) AR111 (No incluidas)  
Base G53  
2×50 W 12 V~ | 127 V~  
IP 20 Pza. caj. 8

\* Modelo dirigible.



\* Con opción a transformador de 12 V~ para lámpara de halógeno.  
\* Permiten el uso con sensor de movimiento SE-2101.B o SE-2102.B (Pág. 103).





Interior / Techo / Sobreponer / Sin LED integrado

## Luminarios Downlight de sobreponer |

Fabricados en policarbonato



TL-2915.B *BLANCO*  
TL-2915.N *NEGRO*

Lámpara MR16 LED  
No incluida  
Base GU5.3  
15 W máx.  
127 V~  
IP 20

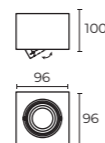

TL-2916.B *BLANCO*  
TL-2916.N *NEGRO*

Lámpara MR16 LED  
No incluida  
Base GU5.3  
15 W máx.  
127 V~  
IP 20

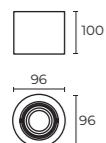

TL-2930.B *BLANCO*  
TL-2930.N *NEGRO*

Lámpara MR16 LED  
No incluida  
Base GU5.3  
2×15 W máx.  
127 V~  
IP 20

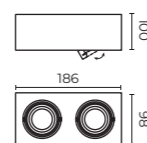

MONTAJE Y DIRECCIÓN DE LA LUZ



TL-2915  
TL-2916  
TL-2930

- \* Compatible únicamente con lámparas LED Illux.
- \* Requiere driver para bajo voltaje.
- \* Sugerencia de lámpara FL-10MR16.530 de 3 000 K o FL-10MR16.540 de 4 000 K (*Pág. 110*).



PROYECTO: Lomas de Vista Hermosa  
LUMINARIA: TL-2916.N

Interior / Techo / Riel / Sin LED integrado

## Luminarios tipo Spot |

Fabricados en fundición de aluminio



TL-5150.RB

TL-5150.RN



### TL-5150.RB BLANCO

GU10 (No incluida)  
Base GU10  
50 W 120 V~  
IP 20 Pza. caj. 50

### TL-5150.RN NEGRO

GU10 (No incluida)  
Base GU10  
50 W 120 V~  
IP 20 Pza. caj. 50

### TL-5100.RB10 BLANCO

### TL-5100.RBSUS1010 BLANCO

Montaje:  
Sobreponer / Suspender  
Medida: 1 m 2 circuitos  
Voltaje: 120 V~  
Pza. caj. 20

### TL-5100.RN10 NEGRO

### TL-5100.RNSUS1010 NEGRO

Montaje:  
Sobreponer / Suspender  
Medida: 1 m 2 circuitos  
Voltaje: 120 V~  
Pza. caj. 20

### TL-5100.RB20 BLANCO

### TL-5100.RBSUS2010 BLANCO

Montaje:  
Sobreponer / Suspender  
Medida: 2 m 2 circuitos  
Voltaje: 120 V~  
Pza. caj. 20

### TL-5100.RN20 NEGRO

### TL-5100.RNSUS2010 NEGRO

Montaje:  
Sobreponer / Suspender  
Medida: 2 m 2 circuitos  
Voltaje: 120 V~  
Pza. caj. 20

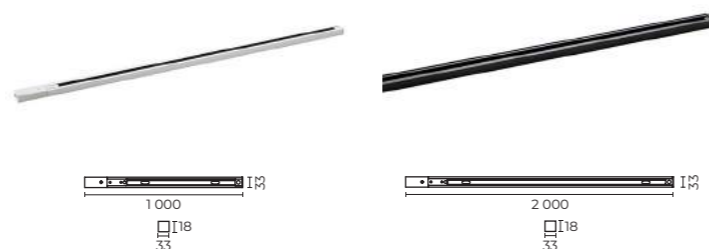

### ACCESORIOS PARA MODELO TL-5150 (NO INCLUIDOS)

#### TL-5150.Louvre

Rejilla difusora de luz



\* No incluye lámpara. Sugerencia de lámpara FL-10GU10 (Pág. 110)

\* Compatible con riel TL-5100

\* En la versión en suspender del riel TL-5100, el máximo de la altura de suspensión es de 1 m.

Interior / Techo / Riel

## Riel para Sobreponer o Suspender |

Fabricados en fundición de aluminio

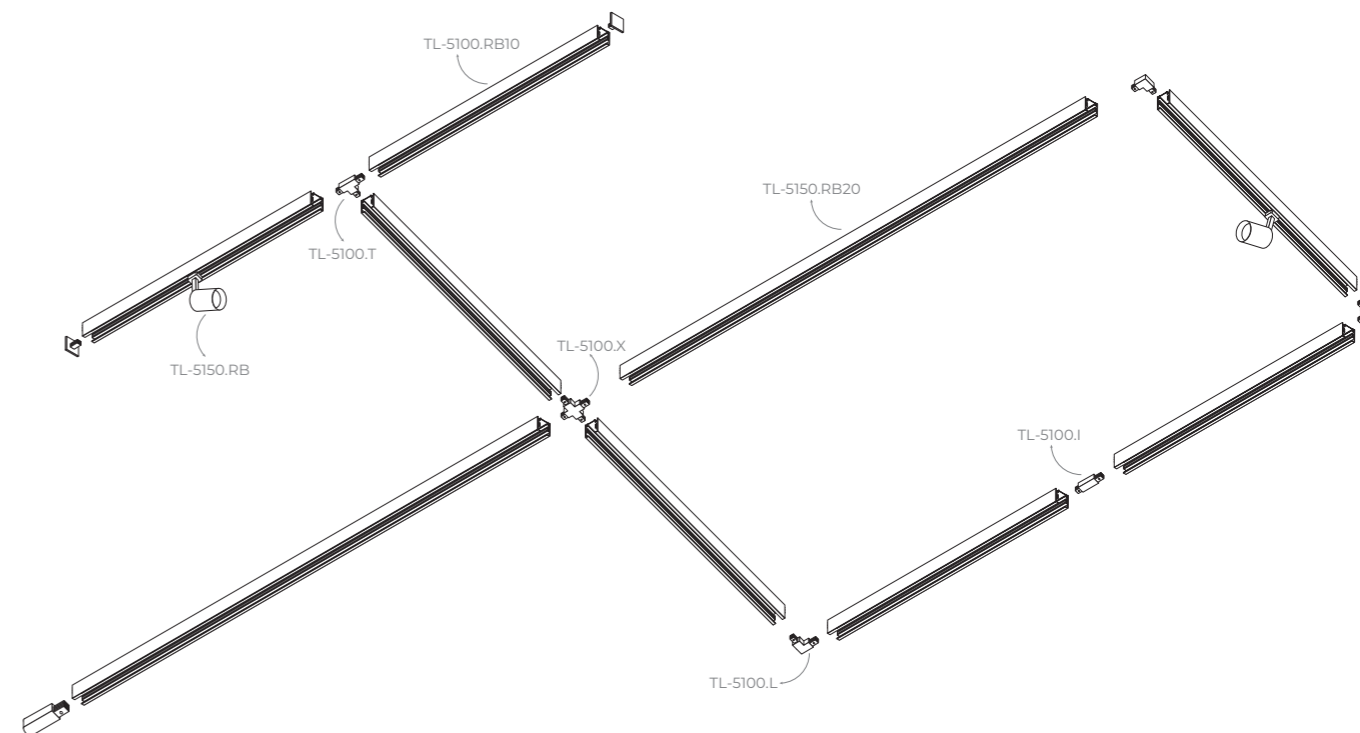

### TL-5100.IB BLANCO

50 W  
IP 20  
Pza. caj. 100

### TL-5100.IN NEGRO

50 W  
IP 20  
Pza. caj. 100

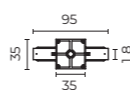

### TL-5100.LB BLANCO

50 W  
IP 20  
Pza. caj. 100

### TL-5100.LN NEGRO

50 W  
IP 20  
Pza. caj. 100

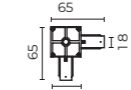

### TL-5100.TB BLANCO

50 W  
IP 20  
Pza. caj. 100

### TL-5100.TN NEGRO

50 W  
IP 20  
Pza. caj. 100

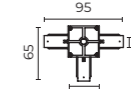

### TL-5100.XB BLANCO

50 W  
IP 20  
Pza. caj. 100

### TL-5100.XN NEGRO

50 W  
IP 20  
Pza. caj. 100

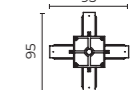

\* No incluyen luminaria.

\* Máximo 5 luminarias por metro.

\* Compatibles con luminaria TL-5150.R

Interior / Techo / Riel / Sin LED integrado

## Luminarios tipo Spot |

Fabricados en fundición de aluminio



•TL-5175.RB

•TL-5175.RN

**nuevo**

### TL-5175.RB *BLANCO*

PAR30 (No incluida)  
Base E26  
75 W máx 120 V~  
IP 20 Pza. caj. 50

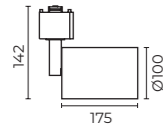

**nuevo**

### TL-5175.RN *NEGRO*

PAR30 (No incluida)  
Base E26  
75 W máx 120 V~  
IP 20 Pza. caj. 50

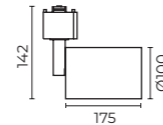

ACCESORIOS PARA MODELO TL-5150 (NO INCLUIDOS)

- TL-5175.Louvre  
Rejilla difusora de luz



TL-5175

- \* No incluye lámpara.
- \* Compatible con riel TL-5100
- \* En la versión en suspender del riel TL-5100, el máximo de la altura de suspensión es de 1 m.



PROYECTO: Dress Shop  
LUMINARIA: TL-5175.RB

Interior / Techo / Sobreponer / Sin LED integrado

## Luminarios tipo Spot con Canope |

Fabricados en fundición de aluminio



Interior / Techo / Sobreponer / Sin LED integrado

## Luminarios tipo Spot |

Fabricados en fundición de aluminio



• TL-5150.SORB



• TL-5150.SORN



nuevo

### TL-5150.BCAN *BLANCO*

GU10 (No incluida)  
Base GU10  
50 W 120 V~  
IP 20 Pza. caj. 50

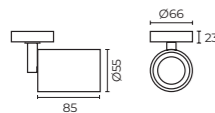

nuevo

### TL-5150.NCAN *NEGRO*

GU10 (No incluida)  
Base GU10  
50 W 120 V~  
IP 20 Pza. caj. 50

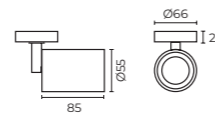

nuevo

### TL-5150.SORB *BLANCO*

GU10 (No incluida)  
Base GU10  
50 W 120 V~  
IP 20 Pza. caj. 50



nuevo

### TL-5150.SORN *NEGRO*

GU10 (No incluida)  
Base GU10  
50 W 120 V~  
IP 20 Pza. caj. 50



ACCESORIOS PARA MODELO TL-5150 (NO INCLUIDOS)

#### • TL-5150.Louvre

Rejilla difusora de luz.



\* No incluye lámpara. Sugerencia de lámpara GU10 LED atenuable FL-10GU10.527 de 2 700 K, FL-10GU10.530 de 3 000 K o FL-10GU10.565 de 6 500 K (**Pág. 110**).  
\* Compatible con riel TL-5100

ACCESORIOS PARA MODELO TL-5150 (NO INCLUIDOS)

#### • TL-5150.Louvre

Rejilla difusora de luz



\* No incluye lámpara. Sugerencia de lámpara GU10 LED atenuable FL-10GU10.527 de 2 700 K, FL-10GU10.530 de 3 000 K o FL-10GU10.565 de 6 500 K (**Pág. 110**).  
\* Compatible con riel TL-5100

# LUMINARIOS DE INTERIOR PARA SOBREPONER EN TECHO |



PROYECTO: Oficinas SIGMA Monterrey  
LUMINARIA: TL-1507.B | TL-1510.B | TL-1513.B

Interior / Techo / Sobreponer / LED

## Luminarios interconectables LED |

Fabricados en aluminio

• TL-1507.B / TL-1507.BSENS



• TL-1510.B

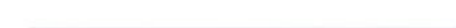

• TL-1513.B / TL-1513.BSENS



• TL-1536.B



• Con sensor

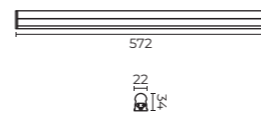

LED

**TL-1507.B24 BLANCO**

SMD LED 2835  
9 W 100 - 277 V~ FP 0.9  
2 400 K 680 lm IRC ≥80  
IP 20 20 000 h Pza. caj. 30

**TL-1507.B27 BLANCO**

SMD LED 2835  
9 W 100 - 277 V~ FP 0.9  
2 700 K 700 lm IRC ≥80  
IP 20 20 000 h Pza. caj. 30

**TL-1507.B30 BLANCO**

SMD LED 2835  
9 W 100 - 277 V~ FP 0.9  
3 000 K 720 lm IRC ≥80  
IP 20 20 000 h Pza. caj. 30

**TL-1507.B40 BLANCO**

SMD LED 2835  
9 W 100 - 277 V~ FP 0.9  
4 000 K 780 lm IRC ≥80  
IP 20 20 000 h Pza. caj. 30

**TL-1507.B65 BLANCO**

SMD LED 2835  
9 W 100 - 277 V~ FP 0.9  
6 500 K 810 lm IRC ≥80  
IP 20 20 000 h Pza. caj. 30

LED

**TL-1507.B24DIM BLANCO**

SMD LED 2835  
9 W 110 - 130 V~ FP 0.9  
2 400 K 680 lm IRC ≥80  
IP 20 20 000 h Pza. caj. 30

**TL-1507.B27DIM BLANCO**

SMD LED 2835  
9 W 110 - 130 V~ FP 0.9  
2 700 K 700 lm IRC ≥80  
IP 20 20 000 h Pza. caj. 30

**TL-1507.B30DIM BLANCO**

SMD LED 2835  
9 W 110 - 130 V~ FP 0.9  
3 000 K 720 lm IRC ≥80  
IP 20 20 000 h Pza. caj. 30

**TL-1507.B40DIM BLANCO**

SMD LED 2835  
9 W 110 - 130 V~ FP 0.9  
4 000 K 780 lm IRC ≥80  
IP 20 20 000 h Pza. caj. 30

**TL-1507.B65DIM BLANCO**

SMD LED 2835  
9 W 110 - 130 V~ FP 0.9  
6 500 K 810 lm IRC ≥80  
IP 20 20 000 h Pza. caj. 30

LED

**TL-1507.B24SENS BLANCO**

SMD LED 2835  
9 W 100 - 277 V~ FP 0.9  
2 400 K 680 lm IRC ≥80  
IP 20 20 000 h Pza. caj. 30

**TL-1507.B27SENS BLANCO**

SMD LED 2835  
9 W 100 - 277 V~ FP 0.9  
2 700 K 700 lm IRC ≥80  
IP 20 20 000 h Pza. caj. 30

\* Cuentan con sensor de movimiento integrado.

CONEXIÓN ESPECIAL (SOBRE PEDIDO)

• Salida lateral o dorsal.



- \* Driver integrado.
- \* Incluyen accesorios para fijación y conector.
- \* Permiten el uso con sensor de movimiento SE-2101.B o SE-2102.B (Pág. 103).

## Luminarios interconectables LED |

Fabricados en aluminio

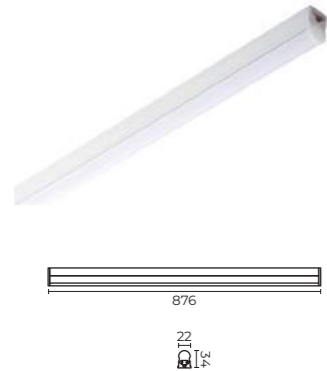

LED

**TL-1510.B24 BLANCO**

SMD LED 2835  
14 W 100 - 277 V~ FP 0.9  
2 400 K 1 080 lm IRC ≥80  
IP 20 20 000 h Pza. caj. 30

**TL-1510.B24DIM BLANCO**

SMD LED 2835  
14 W 110 - 130 V~ FP 0.9  
2 400 K 1 080 lm IRC ≥80  
IP 20 20 000 h Pza. caj. 30

**TL-1510.B27 BLANCO**

SMD LED 2835  
14 W 100 - 277 V~ FP 0.9  
2 700 K 1 100 lm IRC ≥80  
IP 20 20 000 h Pza. caj. 30

**TL-1510.B27DIM BLANCO**

SMD LED 2835  
14 W 110 - 130 V~ FP 0.9  
2 700 K 1 100 lm IRC ≥80  
IP 20 20 000 h Pza. caj. 30

**TL-1510.B30 BLANCO**

SMD LED 2835  
14 W 100 - 277 V~ FP 0.9  
3 000 K 1 120 lm IRC ≥80  
IP 20 20 000 h Pza. caj. 30

**TL-1510.B30DIM BLANCO**

SMD LED 2835  
14 W 110 - 130 V~ FP 0.9  
3 000 K 1 120 lm IRC ≥80  
IP 20 20 000 h Pza. caj. 30

**TL-1510.B40 BLANCO**

SMD LED 2835  
14 W 100 - 277 V~ FP 0.9  
4 000 K 1 220 lm IRC ≥80  
IP 20 20 000 h Pza. caj. 30

**TL-1510.B40DIM BLANCO**

SMD LED 2835  
14 W 110 - 130 V~ FP 0.9  
4 000 K 1 220 lm IRC ≥80  
IP 20 20 000 h Pza. caj. 30

**TL-1510.B65 BLANCO**

SMD LED 2835  
14 W 100 - 277 V~ FP 0.9  
6 500 K 1 260 lm IRC ≥80  
IP 20 20 000 h Pza. caj. 30

**TL-1510.B65DIM BLANCO**

SMD LED 2835  
14 W 110 - 130 V~ FP 0.9  
6 500 K 1 260 lm IRC ≥80  
IP 20 20 000 h Pza. caj. 30

**CONEXIÓN ESPECIAL (SOBRE PEDIDO)**

- Salida lateral o dorsal.



MONTAJE Y DIRECCIÓN DE LA LUZ



TL-1510

- \* Driver integrado.
- \* Incluyen accesorios para fijación y conector.
- \* Permiten el uso con sensor de movimiento SE-2101.B o SE-2102.B (Pág. 103).

## Luminarios interconectables LED |

Fabricados en aluminio



LED

**TL-1513.B24 BLANCO**

SMD LED 2835  
18 W 100 - 277 V~ FP 0.9  
2 400 K 1 360 lm IRC ≥80  
IP 20 20 000 h Pza. caj. 30

**TL-1513.B27 BLANCO**

SMD LED 2835  
18 W 100 - 277 V~ FP 0.9  
2 700 K 1 380 lm IRC ≥80  
IP 20 20 000 h Pza. caj. 30

**TL-1513.B30 BLANCO**

SMD LED 2835  
18 W 100 - 277 V~ FP 0.9  
3 000 K 1 440 lm IRC ≥80  
IP 20 20 000 h Pza. caj. 30

**TL-1513.B40 BLANCO**

SMD LED 2835  
18 W 100 - 277 V~ FP 0.9  
4 000 K 1 580 lm IRC ≥80  
IP 20 20 000 h Pza. caj. 30

**TL-1513.B65 BLANCO**

SMD LED 2835  
18 W 100 - 277 V~ FP 0.9  
6 500 K 1 620 lm IRC ≥80  
IP 20 20 000 h Pza. caj. 30

**TL-1513.B24SENS BLANCO**

SMD LED 2835  
18 W 100 - 277 V~ FP 0.9  
2 400 K 1 360 lm IRC ≥80  
IP 20 20 000 h Pza. caj. 30

**TL-1513.B27SENS BLANCO**

SMD LED 2835  
18 W 100 - 277 V~ FP 0.9  
2 700 K 1 380 lm IRC ≥80  
IP 20 20 000 h Pza. caj. 30

- \* Cuentan con sensor de movimiento integrado.

**TL-1513.B24DIM BLANCO**

SMD LED 2835  
18 W 110 - 130 V~ FP 0.9  
2 400 K 1 360 lm IRC ≥80  
IP 20 20 000 h Pza. caj. 30

**TL-1513.B27DIM BLANCO**

SMD LED 2835  
18 W 110 - 130 V~ FP 0.9  
2 700 K 1 380 lm IRC ≥80  
IP 20 20 000 h Pza. caj. 30

**TL-1513.B30DIM BLANCO**

SMD LED 2835  
18 W 110 - 130 V~ FP 0.9  
3 000 K 1 440 lm IRC ≥80  
IP 20 20 000 h Pza. caj. 30

**TL-1513.B40DIM BLANCO**

SMD LED 2835  
18 W 110 - 130 V~ FP 0.9  
4 000 K 1 580 lm IRC ≥80  
IP 20 20 000 h Pza. caj. 30

**TL-1513.B65DIM BLANCO**

SMD LED 2835  
18 W 110 - 130 V~ FP 0.9  
6 500 K 1 620 lm IRC ≥80  
IP 20 20 000 h Pza. caj. 30

**nuevo** LED**TL-1536.B30 BLANCO**

SMD LED 2835  
36 W 100 - 277 V~ FP 0.9  
3 000 K 2 600 lm IRC ≥80  
IP 20 20 000 h Pza. caj. 25

**TL-1536.B40 BLANCO**

SMD LED 2835  
36 W 100 - 277 V~ FP 0.9  
4 000 K 2 800 lm IRC ≥80  
IP 20 20 000 h Pza. caj. 25

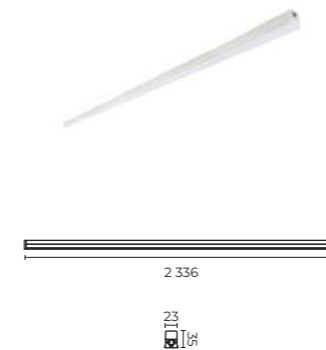

MONTAJE Y DIRECCIÓN DE LA LUZ



TL-1536

- \* Driver integrado.
- \* Incluyen accesorios para fijación y conector.
- \* Permiten el uso con sensor de movimiento SE-2101.B o SE-2102.B (Pág. 103).



Interior / Techo / Sobreponer / LED

## Regleta MAX interconectables LED |

Fabricados en aluminio

· TL-1514.B30



· TL-1519.B30



· TL-1526.B30



nuevo LED

**TL-1514.B30** BLANCO

SMD LED 2835  
14 W 100 - 277 V~ FP 0.9  
3 000 K 1 300 lm IRC ≥80  
IP 20 20 000 h Pza. caj. 30



nuevo LED

**TL-1519.B30** BLANCO

SMD LED 2835  
20 W 100 - 277 V~ FP 0.9  
3 000 K 1 900 lm IRC ≥80  
IP 20 20 000 h Pza. caj. 30

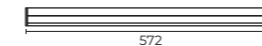

572

23  
16

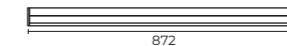

872

23  
16



nuevo LED

**TL-1526.B30** BLANCO

SMD LED 2835  
26 W 100 - 277 V~ FP 0.9  
3 000 K 2 500 lm IRC ≥80  
IP 20 20 000 h Pza. caj. 30

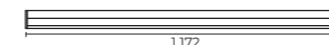

1172

23  
35

MONTAJE Y DIRECCIÓN DE LA LUZ



TL-1514  
TL-1519  
TL-1526

\* Driver integrado.

\* Incluyen accesorios para fijación y conector.

\* Permiten el uso con sensor de movimiento SE-2101.B o SE-2102.B (Pág. 103).

Interior / Techo / Sobreponer / LED

## Luminarios interconectables LED |

Fabricado en ABS



LED  
**TL-3418.B65 BLANCO**  
SMD LED  
2x18 W 100 - 277 V~  
6 500 K 2 640 lm IRC ≥80  
IP 20 20 000 h Pza. caj. 20

\* Opera dos lamparas de 18 W (*no desmontables*).  
\* Se pueden interconectar hasta 10 luminarios.

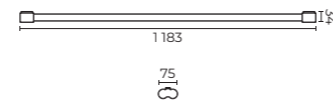

## Luminarios LED |

Fabricados en aluminio con difusor opalino

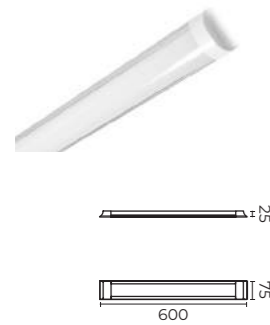

LED  
**TL-1818.B BLANCO**  
SMD LED  
18 W 100 - 277 V~  
4 000 K 1 562 lm IRC ≥80  
IP 20 20 000 h Pza. caj. 10

**TL-1818.B65 BLANCO**  
SMD LED  
18 W 100 - 277 V~  
6 500 K 1 562 lm IRC ≥80  
IP 20 20 000 h Pza. caj. 10

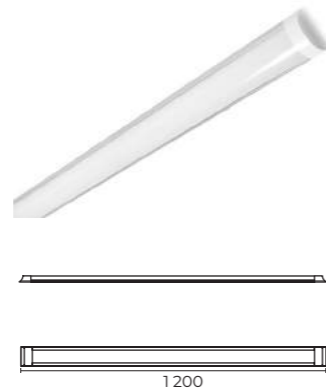

LED  
**TL-1836.B BLANCO**  
SMD LED  
36 W 100 - 277 V~  
4 000 K 3 060 lm IRC ≥80  
IP 20 20 000 h Pza. caj. 20

**TL-1836.B65 BLANCO**  
SMD LED  
36 W 100 - 277 V~  
6 500 K 3 060 lm IRC ≥80  
IP 20 20 000 h Pza. caj. 20



\* Driver integrado.  
\* Permiten el uso con sensor de movimiento SE-2101.B o SE-2102.B (Pág. 103).

Interior / Techo / Sobreponer / LED

## Luminarios interconectables LED |

Fabricado en aluminio v PC



**nuevo** LED  
**TL-1517.B30 BLANCO**  
SMD 2835  
16 W 100 - 277 V~  
3 000 K 1 520 lm IRC ≥80  
IP 20 20 000 h Pza. caj. 25

**TL-1517.B40 BLANCO**  
SMD 2835  
16 W 100 - 277 V~  
4 000 K 1 600 lm IRC ≥80  
IP 20 20 000 h Pza. caj. 25

\* Se pueden interconectar hasta 12 luminarios.

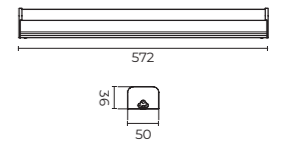

**nuevo** LED  
**TL-1532.B30 BLANCO**  
SMD 2835  
32 W 100 - 277 V~  
3 000 K 3 040 lm IRC ≥80  
IP 20 20 000 h Pza. caj. 25

**TL-1532.B40 BLANCO**  
SMD 2835  
32 W 100 - 277 V~  
4 000 K 3 200 lm IRC ≥80  
IP 20 20 000 h Pza. caj. 25

\* Se pueden interconectar hasta 6 luminarios.

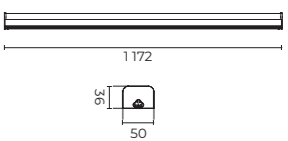

\* Driver integrado.  
\* Interconector incluido, con opción a conexión trasera sobre pedido.  
\* Permiten el uso con sensor de movimiento SE-2101.B o SE-2102.B (Pág. 103).



## Luminarios LED redondos |

Fabricados en aluminio y PC



·TL-2805.B TL-2805.N TL-2808.B TL-2808.N ·TL-2815.B ·TL-2815.N

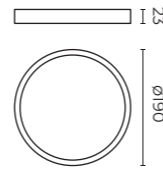
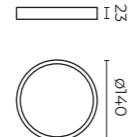
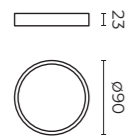

**nuevo** LED

**TL-2805.B30 BLANCO**  
**TL-2805.N30 NEGRO**

SMD LED  
6 W 100 - 277 V~ FP 0.9  
3 000 K 425 lm IRC ≥80  
IP 20 30 000 h Pza. caj. 40

**TL-2805.B40 BLANCO**  
**TL-2805.N40 NEGRO**

SMD LED  
6 W 100 - 277 V~ FP 0.9  
4 000 K 425 lm IRC ≥80  
IP 20 30 000 h Pza. caj. 40

**TL-2805.B65 BLANCO**  
**TL-2805.N65 NEGRO**

SMD LED  
6 W 100 - 277 V~ FP 0.9  
6 500 K 425 lm IRC ≥80  
IP 20 30 000 h Pza. caj. 40

LED

**TL-2808.B30 BLANCO**  
**TL-2808.N30 NEGRO**

SMD LED  
12 W 100 - 277 V~ FP 0.9  
3 000 K 959 lm IRC ≥80  
IP 20 30 000 h Pza. caj. 20

**TL-2808.B40 BLANCO**  
**TL-2808.N40 NEGRO**

SMD LED  
12 W 100 - 277 V~ FP 0.9  
4 000 K 959 lm IRC ≥80  
IP 20 30 000 h Pza. caj. 20

**TL-2808.B65 BLANCO**  
**TL-2808.N65 NEGRO**

SMD LED  
12 W 100 - 277 V~ FP 0.9  
6 500 K 959 lm IRC ≥80  
IP 20 30 000 h Pza. caj. 20

LED

**TL-2815.B30 BLANCO**  
**TL-2815.N30 NEGRO**

SMD LED  
18 W 100 - 277 V~ FP 0.9  
3 000 K 1 427 lm IRC ≥80  
IP 20 30 000 h Pza. caj. 20

**TL-2815.B40 BLANCO**  
**TL-2815.N40 NEGRO**

SMD LED  
18 W 100 - 277 V~ FP 0.9  
4 000 K 425 lm IRC ≥80  
IP 20 30 000 h Pza. caj. 20

**TL-2815.B65 BLANCO**  
**TL-2815.N65 NEGRO**

SMD LED  
18 W 100 - 277 V~ FP 0.9  
6 500 K 425 lm IRC ≥80  
IP 20 30 000 h Pza. caj. 20

## Luminarios LED cuadrados |

Fabricados en aluminio y PC



·TL-2807.B TL-2807.N TL-2809.B TL-2809.N ·TL-2816.B ·TL-2816.N

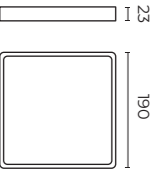
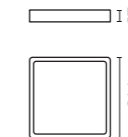
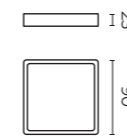

**nuevo** LED

**TL-2807.B30 BLANCO**  
**TL-2807.N30 NEGRO**

SMD LED  
6 W 100 - 277 V~ FP 0.9  
3 000 K 425 lm IRC ≥80  
IP 20 30 000 h Pza. caj. 40

**TL-2807.B40 BLANCO**  
**TL-2807.N40 NEGRO**

SMD LED  
6 W 100 - 277 V~ FP 0.9  
4 000 K 425 lm IRC ≥80  
IP 20 30 000 h Pza. caj. 40

**TL-2807.B65 BLANCO**  
**TL-2807.N65 NEGRO**

SMD LED  
6 W 100 - 277 V~ FP 0.9  
6 500 K 425 lm IRC ≥80  
IP 20 30 000 h Pza. caj. 40

LED

**TL-2809.B30 BLANCO**  
**TL-2809.N30 NEGRO**

SMD LED  
12 W 100 - 277 V~ FP 0.9  
3 000 K 959 lm IRC ≥80  
IP 20 30 000 h Pza. caj. 20

**TL-2809.B40 BLANCO**  
**TL-2809.N40 NEGRO**

SMD LED  
12 W 100 - 277 V~ FP 0.9  
4 000 K 959 lm IRC ≥80  
IP 20 30 000 h Pza. caj. 20

**TL-2809.B65 BLANCO**  
**TL-2809.N65 NEGRO**

SMD LED  
12 W 100 - 277 V~ FP 0.9  
6 500 K 959 lm IRC ≥80  
IP 20 30 000 h Pza. caj. 20

LED

**TL-2816.B30 BLANCO**  
**TL-2816.N30 NEGRO**

SMD LED  
18 W 100 - 277 V~ FP 0.9  
3 000 K 1 427 lm IRC ≥80  
IP 20 30 000 h Pza. caj. 20

**TL-2816.B40 BLANCO**  
**TL-2816.N40 NEGRO**

SMD LED  
18 W 100 - 277 V~ FP 0.9  
4 000 K 1 427 lm IRC ≥80  
IP 20 30 000 h Pza. caj. 20

**TL-2816.B65 BLANCO**  
**TL-2816.N65 NEGRO**

SMD LED  
18 W 100 - 277 V~ FP 0.9  
6 500 K 1 427 lm IRC ≥80  
IP 20 30 000 h Pza. caj. 20



\* Driver integrado.  
\* Permiten el uso con sensor de movimiento SE-2101.B o SE-2102.B (Pág. 103).



\* Driver integrado.  
\* Permiten el uso con sensor de movimiento SE-2101.B o SE-2102.B (Pág. 103).

Interior / Techo / Sobreponer / LED

## Luminarios LED de sobreponer |

Fabricados en acero y PMMA



•TL-6010.B      •TL-6014.B      •TL-6018.B      •TL-6022.B

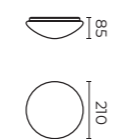

**LED**  
**TL-6010.B30 BLANCO**  
 SMD LED 2835  
 10 W 100 - 277 V~ FP 0.5  
 3 000 K 750 lm IRC ≥80  
 IP 20 20 000 h Pza. caj. 10

**TL-6010.B40 BLANCO**  
 SMD LED 2835  
 10 W 100 - 277 V~ FP 0.5  
 4 000 K 850 lm IRC ≥80  
 IP 20 20 000 h Pza. caj. 10



\* Driver integrado.  
 \* Permiten el uso con sensor de movimiento SE-2101.B o SE-2102.B (Pág. 103).

Interior / Techo / Sobreponer / LED

## Luminarios LED de sobreponer |

Fabricados en acero y PMMA

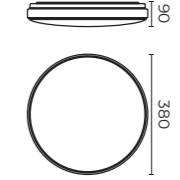
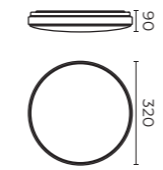

**LED**  
**TL-6018.B30 BLANCO**  
 SMD LED 2835  
 18 W 100 - 277 V~ FP 0.5  
 3 000 K 1 350 lm IRC ≥80  
 IP 20 20 000 h Pza. caj. 10

**TL-6018.B40 BLANCO**  
 SMD LED 2835  
 18 W 100 - 277 V~ FP 0.5  
 4 000 K 1 500 lm IRC ≥80  
 IP 20 20 000 h Pza. caj. 10

**LED**  
**TL-6014.B30 BLANCO**  
 SMD LED 2835  
 14 W 100 - 277 V~ FP 0.5  
 3 000 K 1 050 lm IRC ≥80  
 IP 20 20 000 h Pza. caj. 10

**TL-6014.B40 BLANCO**  
 SMD LED 2835  
 14 W 100 - 277 V~ FP 0.5  
 4 000 K 1 200 lm IRC ≥80  
 IP 20 20 000 h Pza. caj. 10

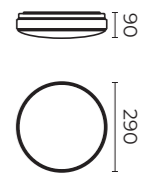

**LED**  
**TL-6022.B30 BLANCO**  
 SMD LED 2835  
 22 W 100 - 277 V~ FP 0.5  
 3 000 K 1 650 lm IRC ≥80  
 IP 20 20 000 h Pza. caj. 10

**TL-6022.B40 BLANCO**  
 SMD LED 2835  
 22 W 100 - 277 V~ FP 0.5  
 4 000 K 1 800 lm IRC ≥80  
 IP 20 20 000 h Pza. caj. 10



\* Driver integrado.  
 \* Permiten el uso con sensor de movimiento SE-2101.B o SE-2102.B (Pág. 103).



Interior / Techo - Muro / Sobreponer/ Sin LED integrado

## Luminarios tipo riel |

Fabricados en acero

nuevo

TR-2401.B *BLANCO*  
TR-2401.N *NEGRO*

GU10 (No incluida)  
Base GU10  
50 W 120 V~  
IP 20 Pza. caj. 24

\* Con apagador integrado.

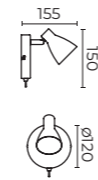

nuevo

TR-2402.B *BLANCO*  
TR-2402.N *NEGRO*

(2) GU10 (No incluidas)  
Base GU10  
2x50 W 120 V~  
IP 20 Pza. caj. 12

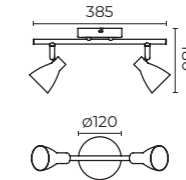

nuevo

TR-2403.B *BLANCO*  
TR-2403.N *NEGRO*

(3) GU10 (No incluidas)  
Base GU10  
3x50 W 120 V~  
IP 20 Pza. caj. 8

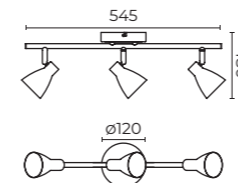

nuevo

TR-2404.B *BLANCO*  
TR-2404.N *NEGRO*

(4) GU10 (No incluidas)  
Base GU10  
4x50 W 120 V~  
IP 20

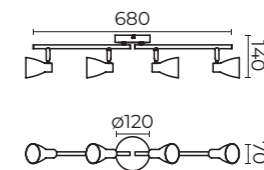

MONTAJE Y DIRECCIÓN DE LA LUZ



TR-2401  
TR-2402  
TR-2403

\* Sugerencia de lámpara GU10 LED atenuable FL-10GU10.527 de 2 700 K, FL-10GU10.530 de 3 000 K o FL-10GU10.565 de 6 500 K (Pág. 110).  
\* Permiten el uso con sensor de movimiento SE-2101.B o SE-2102.B (Pág. 103).

# LUMINARIOS DE INTERIOR PARA SUSPENDER EN TECHO |



PROYECTO: Plaza galerías Ixtapaluca  
LUMINARIA: TL-1040.B

Interior / Techo / Suspendier / LED

## Paneles LED tipo flat |

Fabricados en lámina de aluminio y con difusor opalino de PP

LED

### TL-4740.B40 BLANCO

SMD LED  
40 W 100 - 277 V~ FP 0.9  
4 000 K 3 200 lm IRC ≥80  
IP 65 50 000 h Pza. caj. 5

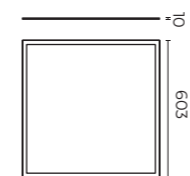

LED

### TL-1039.B30 BLANCO

SMD LED  
40 W 100 - 277 V~ FP 0.9  
3 000 K 2 800 lm IRC ≥80  
IP 42 25 000 h Pza. caj. 5

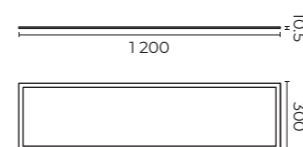

### TL-1039.B40 BLANCO

SMD LED  
40 W 100 - 277 V~ FP 0.9  
4 000 K 2 800 lm IRC ≥80  
IP 42 25 000 h Pza. caj. 5

### TL-1039.B65 BLANCO

SMD LED  
40 W 100 - 277 V~ FP 0.9  
6 500 K 2 800 lm IRC ≥80  
IP 42 25 000 h Pza. caj. 5

LED

### TL-1064.B40 BLANCO

SMD LED  
64 W 100 - 277 V~ FP 0.9  
4 000 K 4 480 lm IRC ≥80  
IP 42 25 000 h Pza. caj. 5

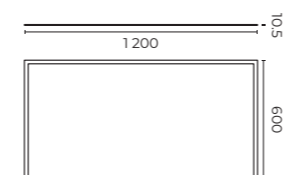
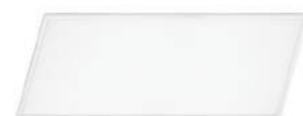

### TL-1064.B65 BLANCO

SMD LED  
64 W 100 - 277 V~ FP 0.9  
6 500 K 4 480 lm IRC ≥80  
IP 42 25 000 h Pza. caj. 5

LED

### TL-1040.B30 BLANCO

SMD LED  
40 W 100 - 277 V~ FP 0.9  
3 000 K 3 200 lm IRC ≥80  
IP 42 25 000 h Pza. caj. 5

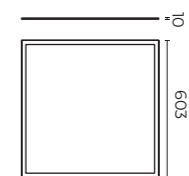

### TL-1040.B40 BLANCO

SMD LED  
40 W 100 - 277 V~ FP 0.9  
4 000 K 3 600 lm IRC ≥80  
IP 42 25 000 h Pza. caj. 5

### TL-1040.B65 BLANCO

SMD LED  
40 W 100 - 277 V~ FP 0.9  
6 500 K 3 200 lm IRC ≥80  
IP 42 25 000 h Pza. caj. 5

### TL-1040.B30DIM BLANCO

SMD LED  
40 W 100 - 277 V~ FP 0.9  
3 000 K 3 200 lm IRC ≥80  
IP 42 25 000 h Pza. caj. 5

### TL-1040.B40DIM BLANCO

SMD LED  
40 W 100 - 277 V~ FP 0.9  
4 000 K 3 600 lm IRC ≥80  
IP 42 25 000 h Pza. caj. 5

### TL-1040.B65DIM BLANCO

SMD LED  
40 W 100 - 277 V~ FP 0.9  
6 500 K 3 200 lm IRC ≥80  
IP 42 25 000 h Pza. caj. 5

ACCESORIOS PARA MODELO TL-1040 (NO INCLUIDOS)

- TL-1040.MAcc Marco color blanco.
- KIT-SUS Kit de suspensión 4 cables.

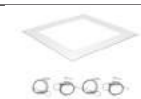

ACCESORIOS PARA MODELO TL-1039 (NO INCLUIDOS)

- TL-1039.MAcc Marco color blanco.
- KIT-SUS6C Kit de suspensión 6 cables.

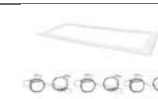

ACCESORIOS PARA MODELO TL-1064 (NO INCLUIDOS)

- TL-1064.MAcc Marco color blanco.
- KIT-SUS6C Kit de suspensión 6 cables.

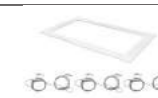

TL-4740  
TL-1040  
TL-1039  
TL-1064

- \* Driver remoto.
- \* Disponibles con batería de emergencia.
- \* Accesorios se venden por separado.
- \* Disponible con sensor de movimiento sobre pedido.
- \* Sistema de suspensión fabricado en cable acerado con suspensión máxima de 1 m.
- \* Permiten el uso con sensor de movimiento SE-2101.B o SE-2102.B (Pág. 103).



Interior / Techo / Suspender / LED

## Luminarios decorativos |

Fabricados en aluminio



LED

DL-4001.S SATIN  
DL-4001.N NEGRO

LED  
30 W 100 - 277 V~  
3 000 K 2 350 lm IRC ≥80  
IP 20 30 000 h Pza. caj.1

DL-4001.S40 SATIN  
DL-4001.N40 NEGRO

LED  
30 W 100 - 277 V~  
4 000 K 2 350 lm IRC ≥80  
IP 20 30 000 h Pza. caj.1

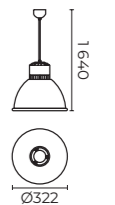

\* Incluye driver integrado.  
\* Luminario decorativo LED para suspender fabricado en aluminio acabado en satín o negro en el exterior y blanco en el interior.



Interior / Techo / Suspendier / LED

## Luminarios decorativos |

Fabricados en aluminio



nuevo

DH-5101.B BLANCO  
DH-5101.N NEGRO

GU10 (No incluidas)  
Base GU10  
50 W 120 V~  
IP 20 Pza. caj. 12

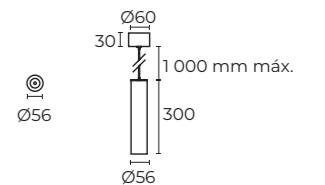

ACCESORIOS PARA MODELO DH-5101 (NO INCLUIDOS)

• TL-5150.Louvre  
Rejilla difusora de luz



\* Altura máxima de suspensión 1 m  
\* Sugerencia de lámpara GU10 LED atenuable FL-10GU10.527 de 2 700 K,  
FL-10GU10.530 de 3 000 K o FL-10GU10.565 de 6 500 K (Pág. 110).

# LUMINARIOS DE INTERIOR LINEALES |



## Luminarios SUPER-LINE interconectables |

Fabricados en aluminio

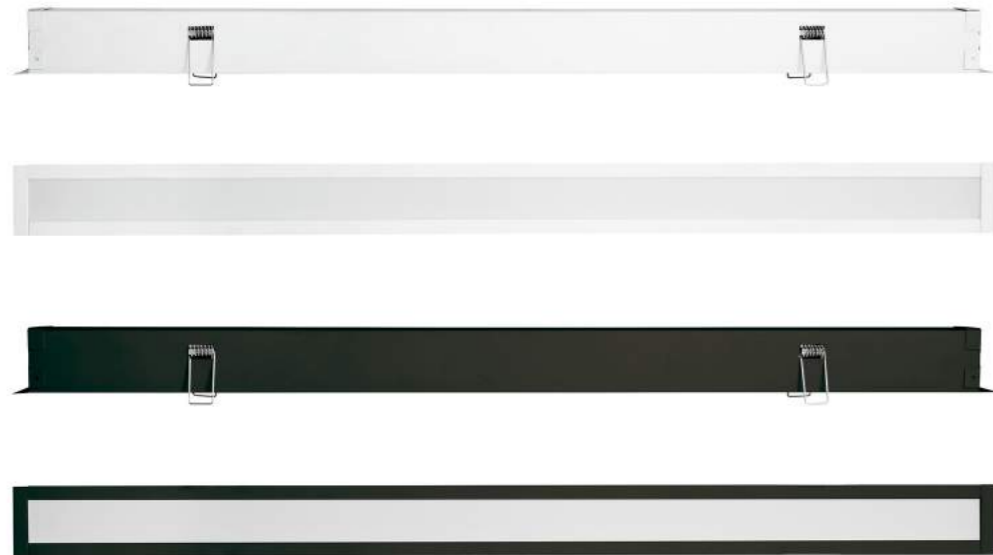

### LED

**TL-1509.B30** BLANCO  
**TL-1509.N30** NEGRO

SMD LED  
9 W 100 - 277 V~ FP 0.9  
3 000 K (Blanco - 800 lm  
Negro - 700 lm) IRC ≥80  
IP 40 20 000 h Pza. caj. 25

**TL-1509.B40** BLANCO  
**TL-1509.N40** NEGRO

SMD LED  
9 W 100 - 277 V~ FP 0.9  
4 000 K (Blanco - 800 lm  
Negro - 780 lm) IRC ≥80  
IP 40 20 000 h Pza. caj. 25

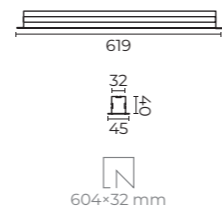

### LED

**TL-1518.B30** BLANCO  
**TL-1518.N30** NEGRO

SMD LED  
18 W 100 - 277 V~ FP 0.9  
3 000 K (Blanco - 1 350 lm  
Negro - 1 300 lm) IRC ≥80  
IP 40 20 000 h Pza. caj. 25

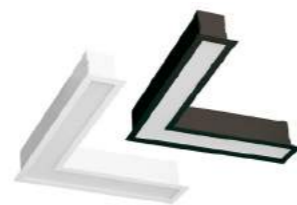

**TL-1518.B40** BLANCO  
**TL-1518.N40** NEGRO

SMD LED  
18 W 100 - 277 V~ FP 0.9  
4 000 K (Blanco - 1 550 lm  
Negro - 1 500 lm) IRC ≥80  
IP 40 20 000 h Pza. caj. 25

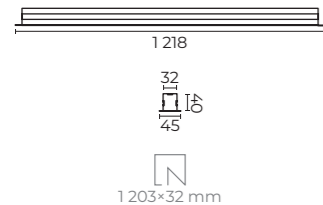

### LED

**TL-1500.B30** BLANCO  
**TL-1500.N30** NEGRO

SMD LED  
6 W 100 - 277 V~ FP 0.9  
3 000 K (Blanco - 500 lm  
Negro - 480 lm) IRC ≥80  
IP 40 20 000 h Pza. caj. 20

**TL-1500.B40** BLANCO  
**TL-1500.N40** NEGRO

SMD LED  
6 W 100 - 277 V~ FP 0.9  
4 000 K (Blanco - 530 lm  
Negro - 500 lm) IRC ≥80  
IP 40 20 000 h Pza. caj. 20

### ACCESORIOS PARA INTERCONEXIÓN (NO INCLUIDO)

- TL-1501.Acc Conector.



### MONTAJE Y DIRECCIÓN DE LA LUZ



TL-1509  
TL-1518  
TL-1500

- \* Driver integrado.
- \* Accesorios se venden por separado.
- \* Se pueden interconectar hasta 10 pzas. por línea de corriente.
- \* Permiten el uso con sensor de movimiento SE-2101.B o SE-2102.B (Pág. 103).

## Esquema de interconectables SUPER-LINE |

Fabricados en aluminio

### TIPOS INTERCONECTABLES

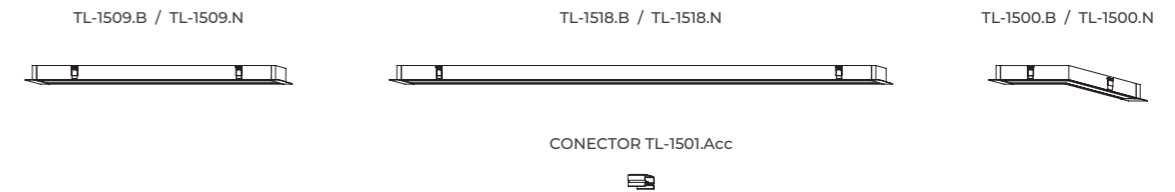

### PASOS DE INTERCONEXIÓN

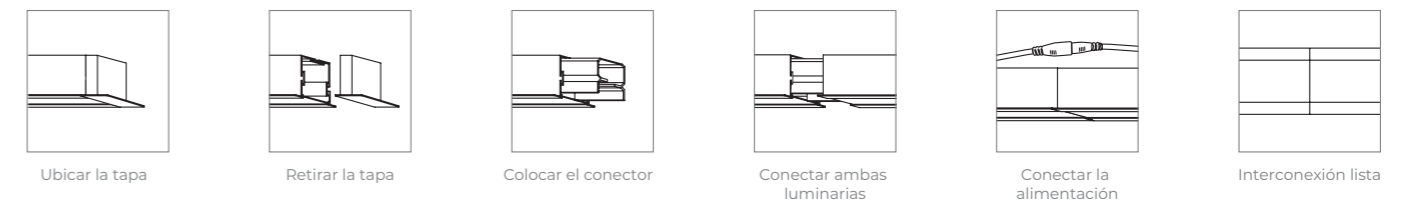

### EJEMPLO DE INTERCONEXIÓN

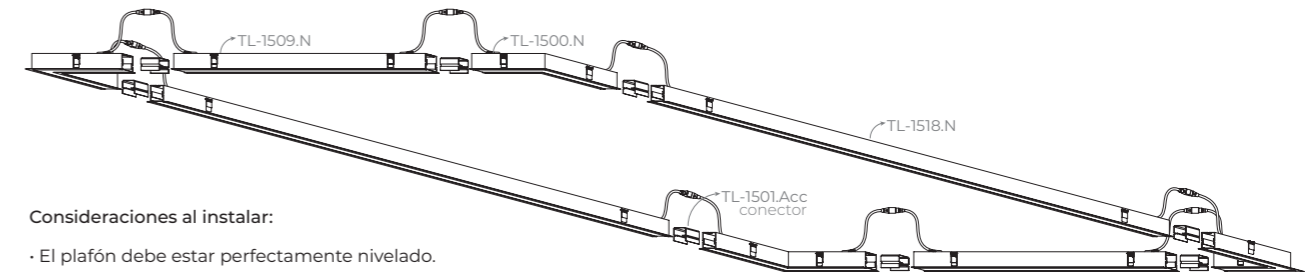

### Consideraciones al instalar:

- El plafón debe estar perfectamente nivelado.
- Las pinzas de sujeción deben de librar la canaleta, por ello se recomienda establecer un margen de 10 cm adicionales en el ancho del luminario, con respecto a las canaletas.
- Si se interconectan utilizar el accesorio de interconexión, para evitar que se muevan los luminarios y que la línea de luz se corte.

### FORMACIÓN DE CÓDIGO INTERCONECTABLES

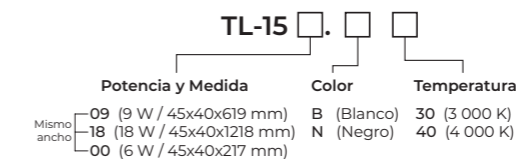

### Nota:

- \* Permiten el uso con sensor de movimiento SE-2101.B o SE-2102.B
- \*\* Máximo 10 luminarias a una línea de corriente.



## Luminarios MEGA-LINE interconectables |

Fabricados en aluminio



LED

**TL-1515.B30** BLANCO  
**TL-1515.N30** NEGRO

SMD LED  
15 W 100 - 277 V~ FP 0,9  
3 000 K (Blanco - 1 400 lm  
Negro - 1 350 lm) IRC ≥80  
IP 20 20 000 h Pza. caj.12

**TL-1515.B40** BLANCO  
**TL-1515.N40** NEGRO

SMD LED  
15 W 100 - 277 V~ FP 0,9  
4 000 K (Blanco - 1 500 lm  
Negro - 1 400 lm) IRC ≥80  
IP 20 20 000 h Pza. caj.12



604x50 mm

LED

**TL-1530.B30** BLANCO  
**TL-1530.N30** NEGRO

SMD LED  
30 W 100 - 277 V~ FP 0,9  
3 000 K (Blanco - 2 800 lm  
Negro - 2 700 lm) IRC ≥80  
IP 20 20 000 h Pza. caj.12

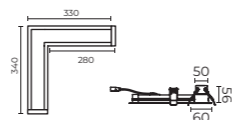

325x325x50 mm

LED

**TL-1516.B30** BLANCO  
**TL-1516.N30** NEGRO

SMD LED  
15 W 100 - 277 V~ FP 0,9  
3 000 K (Blanco - 1 450 lm  
Negro - 1 400 lm) IRC ≥80  
IP 20 20 000 h Pza. caj.10

**TL-1516.B40** BLANCO  
**TL-1516.N40** NEGRO

SMD LED  
15 W 100 - 277 V~ FP 0,9  
4 000 K (Blanco - 1 500 lm  
Negro - 1 450 lm) IRC ≥80  
IP 20 20 000 h Pza. caj.10

### ACCESORIOS PARA INTERCONEXIÓN (INCLUIDO)

- TL-1502.Acc Conector.



1 220



1 204x50 mm

**TL-1530.B40** BLANCO  
**TL-1530.N40** NEGRO

SMD LED  
30 W 100 - 277 V~ FP 0,9  
4 000 K (Blanco - 3 000 lm  
Negro - 2 800 lm) IRC ≥80  
IP 20 20 000 h Pza. caj.12

MONTAJE Y DIRECCIÓN DE LA LUZ



TL-1515  
TL-1530  
TL-1516

- \* Driver integrado.
- \* Atenuación de 0 - 10 V~, sobre pedido.
- \* Incluye 1 conector por luminaria.
- \* Puede ajustarse a los lúmenes requeridos de acuerdo a las necesidades del área, sobre pedido.
- \* Disponibles con atenuación TRIAC a 100 - 130 V~. (TL-1515.B30DIM) (TL-1515.N40DIM) (TL-1530.B30DIM) (TL-1530.N40DIM) (TL-1516.B30DIM) (TL-1516.N40DIM).
- \* Permiten el uso con sensor de movimiento SE-2101.B o SE-2102.B (Pág. 103).

## Esquema de interconectables MEGA-LINE |

Fabricados en aluminio

### TIPOS INTERCONECTABLES

TL-1515.B / TL-1515.N



TL-1530.B / TL-1530.N



TL-1516.B / TL-1516.N



CONECTOR TL-1502.Acc



### PASOS DE INTERCONEXIÓN

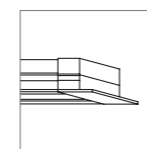

Ubicar la tapa

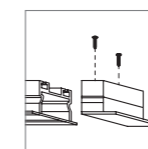

Retirar la tapa

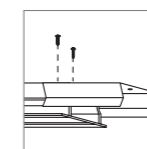

Colocar el conector

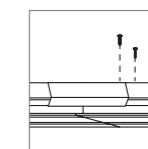

Conectar ambas luminarias

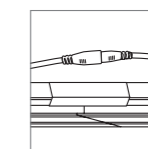

Conectar la alimentación

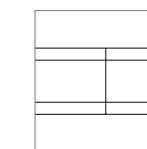

Interconexión lista

### EJEMPLO DE INTERCONEXIÓN

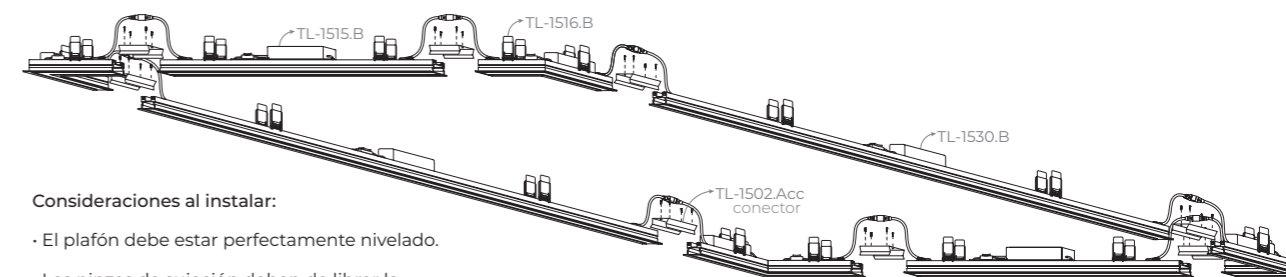

#### Consideraciones al instalar:

- El plafón debe estar perfectamente nivelado.
- Las pinzas de sujeción deben de librar la canaleta, por ello se recomienda establecer un margen de 10 cm adicionales en el ancho del luminario, con respecto a las canaletas.
- Si se interconectan utilizar el accesorio de interconexión, para evitar que se muevan los luminarios y que la línea de luz se corte.

### FORMACIÓN DE CÓDIGO INTERCONECTABLES

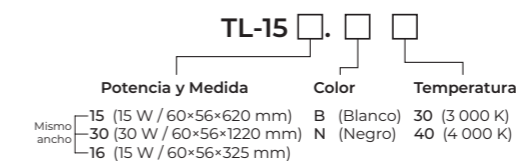

#### Nota:

- \* Permiten el uso con sensor de movimiento SE-2101.B o SE-2102.B
- \*\* Máximo 10 luminarias a una línea de corriente.

## Luminarios ULTRA-LINE interconectables |

Fabricados en lámina de acero con reflector de aluminio difusor de acrílico opalino



LED  
**TL-8128.EMR30** BLANCO  
**TL-8128.NEMR30** NEGRO

LED  
 25 W 120 - 277 V~ FP 0.9  
 3 000 K 4 400 lm IRC ≥80  
 IP 20 50 000 h Pza. caj.1

LED  
**TL-8128.EMR40** BLANCO  
**TL-8128.NEMR40** NEGRO

LED  
 25 W 120 - 277 V~ FP 0.9  
 4 000 K 4 400 lm IRC ≥80  
 IP 20 50 000 h Pza. caj.1



LED  
**TL-8156.EMR30** BLANCO  
**TL-8156.NEMR30** NEGRO

LED  
 50 W 120 - 277 V~ FP 0.9  
 3 000 K 8 800 lm IRC ≥80  
 IP 20 50 000 h Pza. caj.1

LED  
**TL-8156.EMR40** BLANCO  
**TL-8156.NEMR40** NEGRO

LED  
 50 W 120 - 277 V~ FP 0.9  
 4 000 K 8 800 lm IRC ≥80  
 IP 20 50 000 h Pza. caj.1



- \* Driver integrado.
- \* Incluyen driver y tablillas PHILIPS.
- \* Atenuación de 0 - 10 V~, sobre pedido.
- \* Puede ajustarse a los lúmenes requeridos de acuerdo a las necesidades del área, sobre pedido.
- \* TL-8128 puede interconectarse sobre pedido (*Consultar pág. 73*).
- \* Permiten el uso con sensor de movimiento SE-2101.B o SE-2102.B (*Pág. 103*).

## Luminarios ULTRA-LINE interconectables |

Fabricados en lámina de acero con reflector de aluminio difusor de acrílico opalino



LED  
**TL-8128.SOR30** BLANCO  
**TL-8128.NSOR30** NEGRO

LED  
 25 W 120 - 277 V~ FP 0.9  
 3 000 K 4 400 lm IRC ≥80  
 IP 20 50 000 h Pza. caj.1

LED  
**TL-8128.SOR40** BLANCO  
**TL-8128.NSOR40** NEGRO

LED  
 25 W 120 - 277 V~ FP 0.9  
 4 000 K 4 400 lm IRC ≥80  
 IP 20 50 000 h Pza. caj.1



LED  
**TL-8156.SOR30** BLANCO  
**TL-8156.NSOR30** NEGRO

LED  
 50 W 120 - 277 V~ FP 0.9  
 3 000 K 8 800 lm IRC ≥80  
 IP 20 50 000 h Pza. caj.1

LED  
**TL-8156.SOR40** BLANCO  
**TL-8156.NSOR40** NEGRO

LED  
 50 W 120 - 277 V~ FP 0.9  
 4 000 K 8 800 lm IRC ≥80  
 IP 20 50 000 h Pza. caj.1

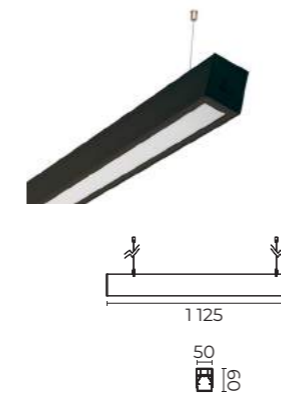

LED  
**TL-8128.SUS30** BLANCO  
**TL-8128.NSUS30** NEGRO

LED  
 25 W 120 - 277 V~ FP 0.9  
 3 000 K 4 400 lm IRC ≥80  
 IP 20 50 000 h Pza. caj.1

LED  
**TL-8128.SUS40** BLANCO  
**TL-8128.NSUS40** NEGRO

LED  
 25 W 120 - 277 V~ FP 0.9  
 4 000 K 4 400 lm IRC ≥80  
 IP 20 50 000 h Pza. caj.1

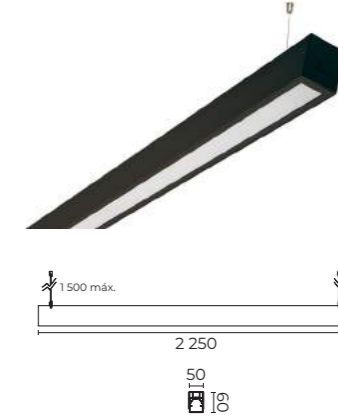

LED  
**TL-8156.SUS30** BLANCO  
**TL-8156.NSUS30** NEGRO

LED  
 50 W 120 - 277 V~ FP 0.9  
 3 000 K 8 800 lm IRC ≥80  
 IP 20 50 000 h Pza. caj.1

LED  
**TL-8156.SUS40** BLANCO  
**TL-8156.NSUS40** NEGRO

LED  
 50 W 120 - 277 V~ FP 0.9  
 4 000 K 8 800 lm IRC ≥80  
 IP 20 50 000 h Pza. caj.1



- \* Driver integrado.
- \* Incluyen driver y tablillas PHILIPS.
- \* Atenuación de 0 - 10 V~, sobre pedido.
- \* Puede ajustarse a los lúmenes requeridos de acuerdo a las necesidades del área, sobre pedido.
- \* TL-8128 puede interconectarse sobre pedido (*Consultar pág. 73*).
- \* Permiten el uso con sensor de movimiento SE-2101.B o SE-2102.B (*Pág. 103*).

## Luminarios ULTRA-LINE interconectables |

Fabricados en lámina de acero con reflector de aluminio difusor de acrílico opalino

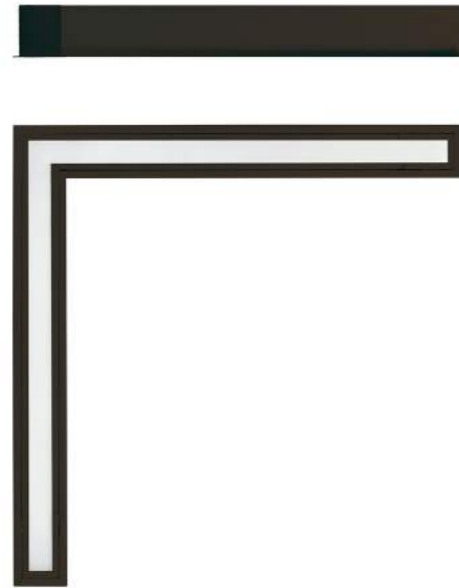

LED  
**TL-8128.ESQEMR30** BLANCO  
**TL-8128.NESQEMR30** NEGRO

LED  
 25 W 120 - 277 V~ FP 0,9  
 3 000 K 4 400 lm IRC ≥80  
 IP 20 50 000 h Pza.caj.1

LED  
**TL-8128.ESQEMR40** BLANCO  
**TL-8128.NESQEMR40** NEGRO

LED  
 25 W 120 - 277 V~ FP 0,9  
 4 000 K 4 400 lm IRC ≥80  
 IP 20 50 000 h Pza.caj.1

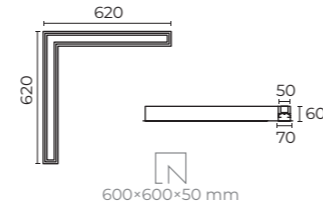

LED  
**TL-8128.ESQSOR30** BLANCO  
**TL-8128.NESQSOR30** NEGRO

LED  
 25 W 120 - 277 V~ FP 0,9  
 3 000 K 4 400 lm IRC ≥80  
 IP 20 50 000 h Pza.caj.1



LED  
**TL-8128.ESQSUS30** BLANCO  
**TL-8128.NESQSUS30** NEGRO

LED  
 25 W 120 - 277 V~ FP 0,9  
 3 000 K 4 400 lm IRC ≥80  
 IP 20 50 000 h Pza.caj.1

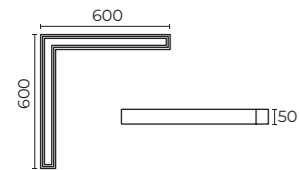

LED  
**TL-8128.ESQSOR40** BLANCO  
**TL-8128.NESQSOR40** NEGRO

LED  
 25 W 120 - 277 V~ FP 0,9  
 4 000 K 4 400 lm IRC ≥80  
 IP 20 50 000 h Pza.caj.1

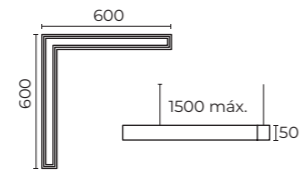

LED  
**TL-8128.ESQSUS40** BLANCO  
**TL-8128.NESQSUS40** NEGRO

LED  
 25 W 120 - 277 V~ FP 0,9  
 4 000 K 4 400 lm IRC ≥80  
 IP 20 50 000 h Pza.caj.1

- \* Driver integrado.
- \* Incluyen driver y tablillas PHILIPS.
- \* Atenuación de 0 - 10 V~, sobre pedido.
- \* Puede ajustarse a los lúmenes requeridos de acuerdo a las necesidades del área, sobre pedido.
- \* Pueden interconectarse, sobre pedido (*Consultar pág. 73*).
- \* Permiten el uso con sensor de movimiento SE-2101.B o SE-2102.B (*Pág. 103*).



## Luminarios PRO-LINE interconectables |

Fabricados en lámina de acero con reflector de aluminio difusor de acrílico opalino

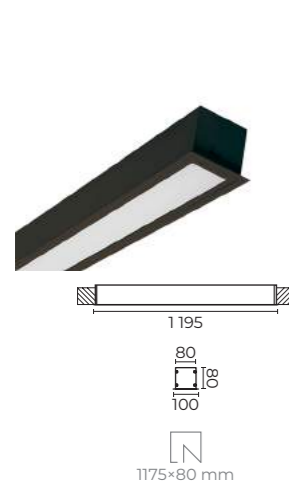

LED  
**TL-8132.EMR30** *BLANCO*  
**TL-8132.NEMR30** *NEGRO*

---

LED  
 25 W 120 - 277 V~ FP 0,9  
 3 000 K 4 400 lm IRC ≥80  
 IP 20 50 000 h Pza. caj.1

---

**TL-8132.EMR40** *BLANCO*  
**TL-8132.NEMR40** *NEGRO*

---

LED  
 25 W 120 - 277 V~ FP 0,9  
 4 000 K 4 400 lm IRC ≥80  
 IP 20 50 000 h Pza. caj.1



LED  
**TL-8164.EMR30** *BLANCO*  
**TL-8164.NEMR30** *NEGRO*

---

LED  
 50 W 120 - 277 V~ FP 0,9  
 3 000 K 8 800 lm IRC ≥80  
 IP 20 50 000 h Pza. caj.1

---

**TL-8164.EMR40** *BLANCO*  
**TL-8164.NEMR40** *NEGRO*

---

LED  
 50 W 120 - 277 V~ FP 0,9  
 4 000 K 8 800 lm IRC ≥80  
 IP 20 50 000 h Pza. caj.1



- \* Driver integrado.
- \* Incluyen driver y tablillas PHILIPS.
- \* Atenuación de 0 - 10 V~, sobre pedido.
- \* Puede ajustarse a los lúmenes requeridos de acuerdo a las necesidades del área, sobre pedido.
- \* TL-8132 puede interconectarse sobre pedido (*Consultar pág. 73*).
- \* Permiten el uso con sensor de movimiento SE-2101.B o SE-2102.B (*Pág. 103*).

## Luminarios PRO-LINE interconectables |

Fabricados en lámina de acero con reflector de aluminio difusor de acrílico opalino



LED  
**TL-8132.SOR30** *BLANCO*  
**TL-8132.NSOR30** *NEGRO*

---

LED  
 25 W 120 - 277 V~ FP 0,9  
 3 000 K 4 400 lm IRC ≥80  
 IP 20 50 000 h Pza. caj.1

---

**TL-8132.SOR40** *BLANCO*  
**TL-8132.NSOR40** *NEGRO*

---

LED  
 25 W 120 - 277 V~ FP 0,9  
 4 000 K 4 400 lm IRC ≥80  
 IP 20 50 000 h Pza. caj.1



LED  
**TL-8164.SOR30** *BLANCO*  
**TL-8164.NSOR30** *NEGRO*

---

LED  
 50 W 120 - 277 V~ FP 0,9  
 3 000 K 8 800 lm IRC ≥80  
 IP 20 50 000 h Pza. caj.1

---

**TL-8164.SOR40** *BLANCO*  
**TL-8164.NSOR40** *NEGRO*

---

LED  
 50 W 120 - 277 V~ FP 0,9  
 4 000 K 8 800 lm IRC ≥80  
 IP 20 50 000 h Pza. caj.1

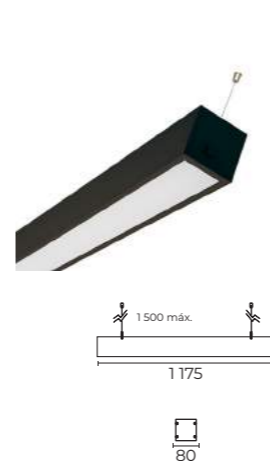

LED  
**TL-8132.SUS30** *BLANCO*  
**TL-8132.NSUS30** *NEGRO*

---

LED  
 25 W 120 - 277 V~ FP 0,9  
 3 000 K 4 400 lm IRC ≥80  
 IP 20 50 000 h Pza. caj.1

---

**TL-8132.SUS40** *BLANCO*  
**TL-8132.NSUS40** *NEGRO*

---

LED  
 25 W 120 - 277 V~ FP 0,9  
 4 000 K 4 400 lm IRC ≥80  
 IP 20 50 000 h Pza. caj.1

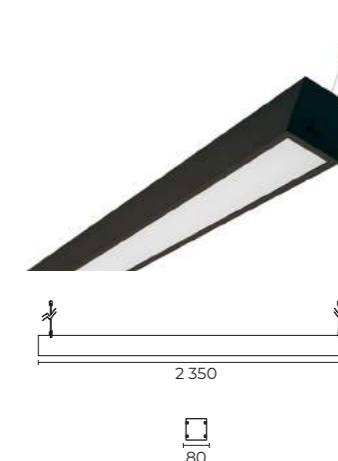

LED  
**TL-8164.SUS30** *BLANCO*  
**TL-8164.NSUS30** *NEGRO*

---

LED  
 50 W 120 - 277 V~ FP 0,9  
 3 000 K 8 800 lm IRC ≥80  
 IP 20 50 000 h Pza. caj.1

---

**TL-8164.SUS40** *BLANCO*  
**TL-8164.NSUS40** *NEGRO*

---

LED  
 50 W 120 - 277 V~ FP 0,9  
 4 000 K 8 800 lm IRC ≥80  
 IP 20 50 000 h Pza. caj.1



- \* Driver integrado.
- \* Incluyen driver y tablillas PHILIPS.
- \* Atenuación de 0 - 10 V~, sobre pedido.
- \* Puede ajustarse a los lúmenes requeridos de acuerdo a las necesidades del área, sobre pedido.
- \* TL-8132 puede interconectarse sobre pedido (*Consultar pág. 73*).
- \* Permiten el uso con sensor de movimiento SE-2101.B o SE-2102.B (*Pág. 103*).

## Luminarios PRO-LINE interconectables |

Fabricados en lámina de acero con reflector de aluminio difusor de acrílico opalino



LED  
**TL-8132.ESQEMR30** BLANCO  
**TL-8132.NESQEMR30** NEGRO  
 LED  
 25 W 120 - 277 V~ FP 0,9  
 3 000 K 4 400 lm IRC ≥80  
 IP 20 50 000 h Pza. caj.1

LED  
**TL-8132.ESQEMR40** BLANCO  
**TL-8132.NESQEMR40** NEGRO  
 LED  
 25 W 120 - 277 V~ FP 0,9  
 4 000 K 4 400 lm IRC ≥80  
 IP 20 50 000 h Pza. caj.1

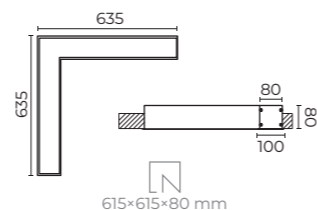

LED  
**TL-8132.ESQSUS30** BLANCO  
**TL-8132.NESQSUS30** NEGRO  
 LED  
 25 W 120 - 277 V~ FP 0,9  
 3 000 K 4 400 lm IRC ≥80  
 IP 20 50 000 h Pza. caj.1

LED  
**TL-8132.ESQSUS40** BLANCO  
**TL-8132.NESQSUS40** NEGRO  
 LED  
 25 W 120 - 277 V~ FP 0,9  
 4 000 K 4 400 lm IRC ≥80  
 IP 20 50 000 h Pza. caj.1

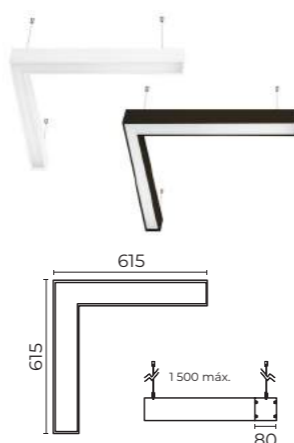

LED  
**TL-8132.ESQSOR30** BLANCO  
**TL-8132.NESQSOR30** NEGRO  
 LED  
 25 W 120 - 277 V~ FP 0,9  
 3 000 K 4 400 lm IRC ≥80  
 IP 20 50 000 h Pza. caj.1

LED  
**TL-8132.ESQSOR40** BLANCO  
**TL-8132.NESQSOR40** NEGRO  
 LED  
 25 W 120 - 277 V~ FP 0,9  
 4 000 K 4 400 lm IRC ≥80  
 IP 20 50 000 h Pza. caj.1

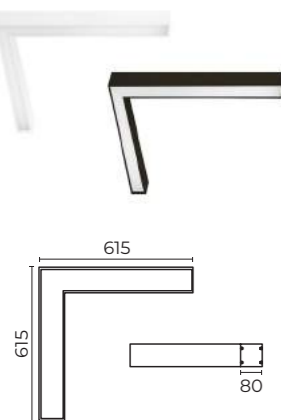

- \* Driver integrado.
- \* Incluyen driver y tablillas PHILIPS.
- \* Atenuación de 0 - 10 V~, sobre pedido.
- \* Puede ajustarse a los lúmenes requeridos de acuerdo a las necesidades del área, sobre pedido.
- \* Pueden interconectarse, sobre pedido (*Consultar pág. 73*).
- \* Permiten el uso con sensor de movimiento SE-2101.B o SE-2102.B (*Pág. 103*).



## Aplicaciones interconectables ULTRA-LINE y PRO-LINE |

Fabricados en lámina de acero con reflector de aluminio difusor de acrílico opalino

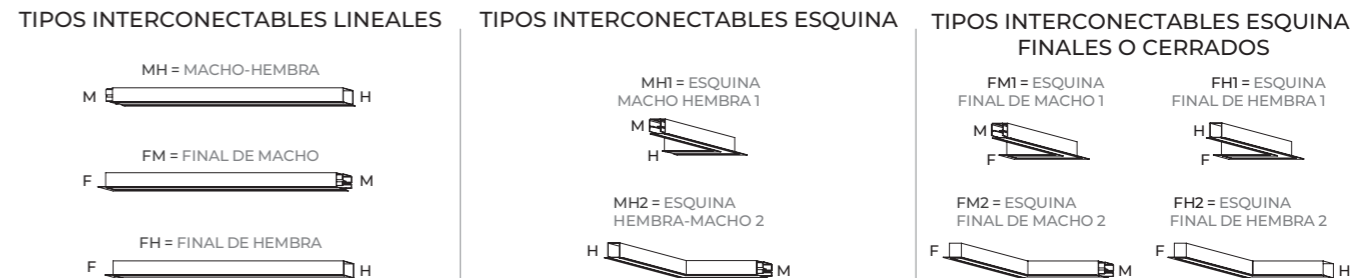

### EJEMPLOS DE INTERCONEXIÓN

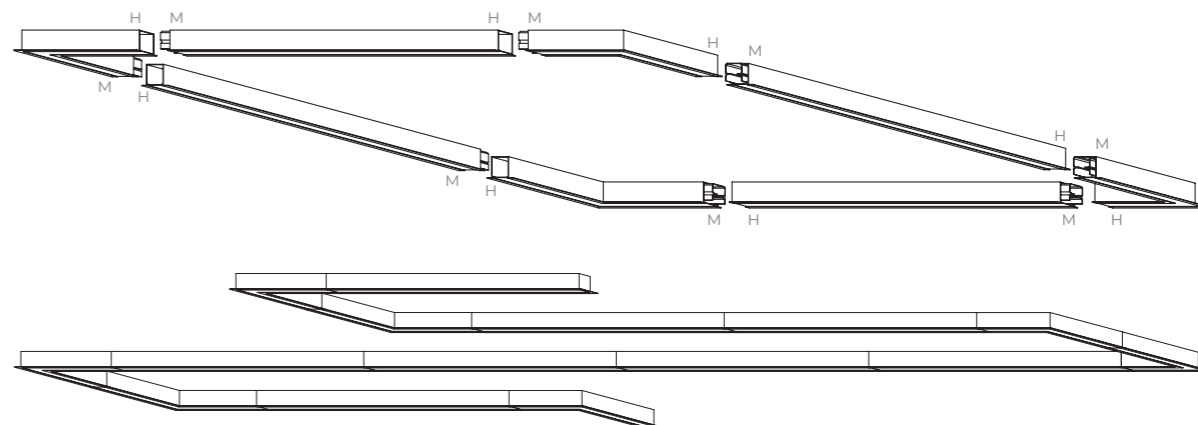

Nota:  
 \* A pesar de su composición lineal, cuentan con gran versatilidad en su conjunción. Debido a ello se pueden generar formas cerradas y convencionales o líneas de luz que adopten formas caprichosas.

### FORMACIÓN DE CÓDIGO INTERCONECTABLES LINEALES

Potencia	Color	Aplicación	Forma	Temperatura	Luz	Atenuable
28 28W	* N Negro	EMR Empotrar SOR Sobreponer SUS Suspende	MH Macho-Hembra FM Final de macho FH Final de hembra	30 3000K 40 4000K	** Directa IND Indirecta DI Directa e indirecta	DIM Atenuable
32 28W						

### FORMACIÓN DE CÓDIGO INTERCONECTABLES ESQUINA

Potencia	Color	Aplicación	Forma	Temperatura	Luz	Atenuable
28 28W	* N Negro	ESQEMR Empotrar ESQSOR Sobreponer ESQSUS Suspende	MH1 Macho-Hembra MH2 Hembra-Macho FM1 Esquina Final de macho 1 FM2 Esquina Final de macho 2 FH1 Esquina Final de hembra 1 FH2 Esquina Final de hembra 2	30 3000K 40 4000K	** Directa IND Indirecta DI Directa e indirecta	DIM Atenuable
32 28W						

Nota:  
 \* Si el luminario es acabado blanco no es necesario agregar ninguna letra.  
 \*\* Si el luminario es de luz directa no es necesario agregar ninguna letra. Sólo se añade si se requiere de LUZ INDIRECTA (IND) o de LUZ DIRECTA E INDIRECTA (DI). Válido únicamente para luminarios de suspender.

NO PUEDEN INTERCONECTARSE MODELOS 28 CON 32 DEBIDO A LAS MEDIDAS DE ANCHO.



Interior / Techo / Empotrar / LINEALES / FLUORESCENTE

## Luminarios PRO-LINE Fluorescentes |

Fabricados en lámina de acero con reflector de aluminio difusor de acrílico opalino

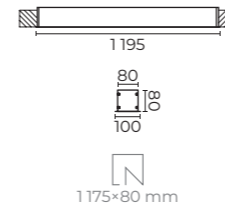

**TF-8125.EMR30** *BLANCO*  
**TF-8125.NEMR30** *NEGRO*

T5 Base G5  
25 W 100 - 277 V~ FP 0.9  
3 000 K 2 639 lm IRC ≥80  
IP 20 35 000 h Pza. caj.1

**TF-8125.EMR40** *BLANCO*  
**TF-8125.NEMR40** *NEGRO*

T5 Base G5  
25 W 100 - 277 V~ FP 0.9  
4 000 K 2 639 lm IRC ≥80  
IP 20 35 000 h Pza. caj.1

**TF-8125.EMR65** *BLANCO*  
**TF-8125.NEMR65** *NEGRO*

T5 Base G5  
25 W 100 - 277 V~ FP 0.9  
6 500 K 2 639 lm IRC ≥80  
IP 20 35 000 h Pza. caj.1

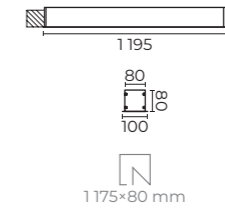

**TF-8150.EMR30** *BLANCO*  
**TF-8150.NEMR30** *NEGRO*

T5 Base G5  
50 W 100 - 277 V~ FP 0.9  
3 000 K 4 650 lm IRC ≥80  
IP 20 35 000 h Pza. caj.1

**TF-8150.EMR40** *BLANCO*  
**TF-8150.NEMR40** *NEGRO*

T5 Base G5  
50 W 100 - 277 V~ FP 0.9  
4 000 K 4 650 lm IRC ≥80  
IP 20 35 000 h Pza. caj.1

**TF-8150.EMR65** *BLANCO*  
**TF-8150.NEMR65** *NEGRO*

T5 Base G5  
50 W 100 - 277 V~ FP 0.9  
6 500 K 4 650 lm IRC ≥80  
IP 20 35 000 h Pza. caj.1

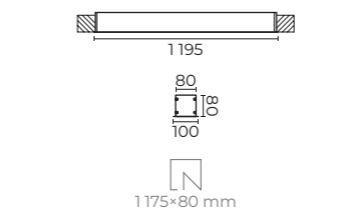

**TF-8225.EMR30** *BLANCO*  
**TF-8225.NEMR30** *NEGRO*

T5 Base G5  
2×25 W 100 - 277 V~ FP 0.9  
3 000 K 5 278 lm IRC ≥80  
IP 20 35 000 h Pza. caj.1

**TF-8225.EMR40** *BLANCO*  
**TF-8225.NEMR40** *NEGRO*

T5 Base G5  
2×25 W 100 - 277 V~ FP 0.9  
4 000 K 5 278 lm IRC ≥80  
IP 20 35 000 h Pza. caj.1

**TF-8225.EMR65** *BLANCO*  
**TF-8225.NEMR65** *NEGRO*

T5 Base G5  
2×25 W 100 - 277 V~ FP 0.9  
6 500 K 5 278 lm IRC ≥80  
IP 20 35 000 h Pza. caj.1

\* Datos aplicables a  
modelos de 2 370 mm

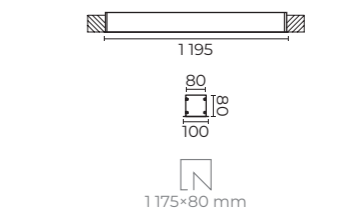

**TF-8250.EMR30** *BLANCO*  
**TF-8250.NEMR30** *NEGRO*

T5 Base G5  
2×50 W 100 - 277 V~ FP 0.9  
3 000 K 9 300 lm IRC ≥80  
IP 20 35 000 h Pza. caj.1

**TF-8250.EMR40** *BLANCO*  
**TF-8250.NEMR40** *NEGRO*

T5 Base G5  
2×50 W 100 - 277 V~ FP 0.9  
4 000 K 9 300 lm IRC ≥80  
IP 20 35 000 h Pza. caj.1

**TF-8250.EMR65** *BLANCO*  
**TF-8250.NEMR65** *NEGRO*

T5 Base G5  
2×50 W 100 - 277 V~ FP 0.9  
6 500 K 9 300 lm IRC ≥80  
IP 20 35 000 h Pza. caj.1

\* Datos aplicables a  
modelos de 2 370 mm

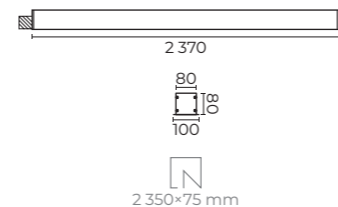

\* Incluyen balastro y lámpara PHILIPS.

\* Para solicitar la luminaria TF-8225 Y TF-8250 en la longitud de 2 370 mm debe añadir "L" al código antes del número, por ejemplo: (TF-8225.EMRL30).

\* Permiten el uso con sensor de movimiento SE-2101.B o SE-2102.B (Pág. 103).

## Luminarios PRO-LINE Fluorescentes |

Fabricados en lámina de acero con reflector de aluminio difusor de acrílico opalino



**TF-8125.SOR30** BLANCO  
**TF-8125.NSOR30** NEGRO

T5 Base G5  
25 W 100 - 277 V~ FP 0.9  
3 000 K 2 639 lm IRC ≥80  
IP 20 35 000 h Pza.caj.1

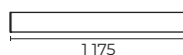

**TF-8125.SOR40** BLANCO  
**TF-8125.NSOR40** NEGRO

T5 Base G5  
25 W 100 - 277 V~ FP 0.9  
4 000 K 2 639 lm IRC ≥80  
IP 20 35 000 h Pza.caj.1

**TF-8125.SOR65** BLANCO  
**TF-8125.NSOR65** NEGRO

T5 Base G5  
25 W 100 - 277 V~ FP 0.9  
6 500 K 2 639 lm IRC ≥80  
IP 20 35 000 h Pza.caj.1



**TF-8150.SOR30** BLANCO  
**TF-8150.NSOR30** NEGRO

T5 Base G5  
50 W 100 - 277 V~ FP 0.9  
3 000 K 4 650 lm IRC ≥80  
IP 20 35 000 h Pza.caj.1

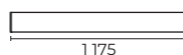

**TF-8150.SOR40** BLANCO  
**TF-8150.NSOR40** NEGRO

T5 Base G5  
50 W 100 - 277 V~ FP 0.9  
4 000 K 4 650 lm IRC ≥80  
IP 20 35 000 h Pza.caj.1

**TF-8150.SOR65** BLANCO  
**TF-8150.NSOR65** NEGRO

T5 Base G5  
50 W 100 - 277 V~ FP 0.9  
6 500 K 4 650 lm IRC ≥80  
IP 20 35 000 h Pza.caj.1



**TF-8225.SOR30** BLANCO  
**TF-8225.NSOR30** NEGRO

T5 Base G5  
2×25 W 100 - 277 V~ FP 0.9  
3 000 K 5 278 lm IRC ≥80  
IP 20 35 000 h Pza.caj.1

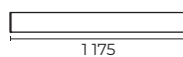

**TF-8225.SOR40** BLANCO  
**TF-8225.NSOR40** NEGRO

T5 Base G5  
2×25 W 100 - 277 V~ FP 0.9  
4 000 K 5 278 lm IRC ≥80  
IP 20 35 000 h Pza.caj.1

**TF-8225.SOR65** BLANCO  
**TF-8225.NSOR65** NEGRO

T5 Base G5  
2×25 W 100 - 277 V~ FP 0.9  
6 500 K 5 278 lm IRC ≥80  
IP 20 35 000 h Pza.caj.1

\* Datos aplicables a modelos de 2 350 mm



**TF-8250.SOR30** BLANCO  
**TF-8250.NSOR30** NEGRO

T5 Base G5  
2×50 W 100 - 277 V~ FP 0.9  
3 000 K 9 300 lm IRC ≥80  
IP 20 35 000 h Pza.caj.1

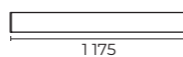

**TF-8250.SOR40** BLANCO  
**TF-8250.NSOR40** NEGRO

T5 Base G5  
2×50 W 100 - 277 V~ FP 0.9  
4 000 K 9 300 lm IRC ≥80  
IP 20 35 000 h Pza.caj.1

**TF-8250.SOR65** BLANCO  
**TF-8250.NSOR65** NEGRO

T5 Base G5  
2×50 W 100 - 277 V~ FP 0.9  
6 500 K 9 300 lm IRC ≥80  
IP 20 35 000 h Pza.caj.1

\* Datos aplicables a modelos de 2 350 mm

MONTAJE Y DIRECCIÓN DE LA LUZ



TF-8125  
TF-8150  
TF-8225  
TF-8250

\* Incluyen balastro y lámpara PHILIPS.  
\* Para solicitar la luminaria TF-8225 Y TF-8250 en la longitud de 2 350 mm debe añadir "L" al código antes del número, por ejemplo: (TF-8225.SORL30).  
\* Permiten el uso con sensor de movimiento SE-2101.B o SE-2102.B (Pág. 103).

## Luminarios PRO-LINE Fluorescentes |

Fabricados en lámina de acero con reflector de aluminio difusor de acrílico opalino



**TF-8125.SUS30** BLANCO  
**TF-8125.NSUS30** NEGRO

T5 Base G5  
25 W 100 - 277 V~ FP 0.9  
3 000 K 2 639 lm IRC ≥80  
IP 20 35 000 h Pza.caj.1



**TF-8125.SUS40** BLANCO  
**TF-8125.NSUS40** NEGRO

T5 Base G5  
25 W 100 - 277 V~ FP 0.9  
4 000 K 2 639 lm IRC ≥80  
IP 20 35 000 h Pza.caj.1

**TF-8125.SUS65** BLANCO  
**TF-8125.NSUS65** NEGRO

T5 Base G5  
25 W 100 - 277 V~ FP 0.9  
6 500 K 2 639 lm IRC ≥80  
IP 20 35 000 h Pza.caj.1



**TF-8150.SUS30** BLANCO  
**TF-8150.NSUS30** NEGRO

T5 Base G5  
50 W 100 - 277 V~ FP 0.9  
3 000 K 4 650 lm IRC ≥80  
IP 20 35 000 h Pza.caj.1



**TF-8150.SUS40** BLANCO  
**TF-8150.NSUS40** NEGRO

T5 Base G5  
50 W 100 - 277 V~ FP 0.9  
4 000 K 4 650 lm IRC ≥80  
IP 20 35 000 h Pza.caj.1

**TF-8150.SUS65** BLANCO  
**TF-8150.NSUS65** NEGRO

T5 Base G5  
50 W 100 - 277 V~ FP 0.9  
6 500 K 4 650 lm IRC ≥80  
IP 20 35 000 h Pza.caj.1



**TF-8225.SUS30** BLANCO  
**TF-8225.NSUS30** NEGRO

T5 Base G5  
2×25 W 100 - 277 V~ FP 0.9  
3 000 K 5 278 lm IRC ≥80  
IP 20 35 000 h Pza.caj.1



**TF-8225.SUS40** BLANCO  
**TF-8225.NSUS40** NEGRO

T5 Base G5  
2×25 W 100 - 277 V~ FP 0.9  
4 000 K 5 278 lm IRC ≥80  
IP 20 35 000 h Pza.caj.1

**TF-8225.SUS65** BLANCO  
**TF-8225.NSUS65** NEGRO

T5 Base G5  
2×25 W 100 - 277 V~ FP 0.9  
6 500 K 5 278 lm IRC ≥80  
IP 20 35 000 h Pza.caj.1

\* Datos aplicables a modelos de 2 350 mm



**TF-8250.SUS30** BLANCO  
**TF-8250.NSUS30** NEGRO

T5 Base G5  
2×50 W 100 - 277 V~ FP 0.9  
3 000 K 9 300 lm IRC ≥80  
IP 20 35 000 h Pza.caj.1



**TF-8250.SUS40** BLANCO  
**TF-8250.NSUS40** NEGRO

T5 Base G5  
2×50 W 100 - 277 V~ FP 0.9  
4 000 K 9 300 lm IRC ≥80  
IP 20 35 000 h Pza.caj.1

**TF-8250.SUS65** BLANCO  
**TF-8250.NSUS65** NEGRO

T5 Base G5  
2×50 W 100 - 277 V~ FP 0.9  
6 500 K 9 300 lm IRC ≥80  
IP 20 35 000 h Pza.caj.1

\* Datos aplicables a modelos de 2 350 mm

MONTAJE Y DIRECCIÓN DE LA LUZ



TF-8125  
TF-8150  
TF-8225  
TF-8250

\* Incluyen balastro y lámpara PHILIPS.  
\* Para solicitar la luminaria TF-8225 Y TF-8250 en la longitud de 2 350 mm debe añadir "L" al código antes del número, por ejemplo: (TF-8225.SUSL30).  
\* Permiten el uso con sensor de movimiento SE-2101.B o SE-2102.B (Pág. 103).

# LUMINARIOS HERMÉTICOS |



PROYECTO: Las Antenas  
LUMINARIA: TL-7136.B / TL-7136.BSENS

Interior - Exterior / Techo / Sobreponer / LED

## Luminarios LED de sobreponer |

Fabricados en policarbonato y PMMA

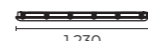
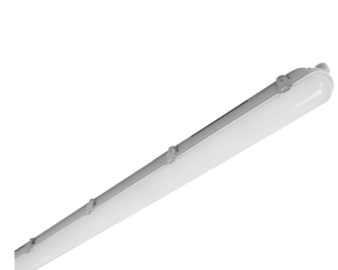

LED

**TL-7145.B BLANCO**

SMD LED  
45 W 100 - 277 V~ FP 0.9  
4 000 K 6 719 lm IRC ≥80  
IP 65 30 000 h Pza. caj. 4

**TL-7145.BEMER BLANCO**

SMD LED  
45 W 100 - 277 V~ FP 0.9  
4 000 K 6 719 lm IRC ≥80  
IP 65 30 000 h Pza. caj. 4

**TL-7145.BSENS ON-OFF**

SMD LED  
45 W 100 - 277 V~ FP 0.9  
4 000 K 6 719 lm IRC ≥80  
IP 65 30 000 h Pza. caj. 4

**TL-7145.BSENSDIM ATENUABLE**

SMD LED  
45 W 100 - 277 V~ FP 0.9  
4 000 K 6 719 lm IRC ≥80  
IP 65 30 000 h Pza. caj. 4



LED

**TL-7115.B BLANCO**

SMD LED  
15 W 120 - 277 V~ FP 0.9  
4 000 K 1 875 lm IRC ≥80  
IP 65 30 000 h Pza. caj. 6

**TL-7115.BEMER BLANCO**

SMD LED  
15 W 120 - 277 V~ FP 0.9  
4 000 K 3 750 lm IRC ≥80  
IP 65 30 000 h Pza. caj. 6

**TL-7115.BSENS ON-OFF**

SMD LED  
15 W 120 - 277 V~ FP 0.9  
4 000 K 3 750 lm IRC ≥80  
IP 65 30 000 h Pza. caj. 6

**TL-7115.BSENSDIM ATENUABLE**

SMD LED  
15 W 100 - 277 V~ FP 0.9  
4 000 K 3 750 lm IRC ≥80  
IP 65 30 000 h Pza. caj. 6

MONTAJE Y DIRECCIÓN DE LA LUZ



TL-7145  
TL-7125  
TL-7131

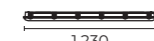

LED

**TL-7125.B BLANCO**

SMD LED  
25 W 120 - 277 V~ FP 0.9  
4 000 K 3 125 lm IRC ≥80  
IP 65 30 000 h Pza. caj. 6

**TL-7125.BEMER BLANCO**

SMD LED  
25 W 120 - 277 V~ FP 0.9  
4 000 K 3 125 lm IRC ≥80  
IP 65 30 000 h Pza. caj. 6

**TL-7125.BSENS ON-OFF**

SMD LED  
25 W 120 - 277 V~ FP 0.9  
4 000 K 3 200 lm IRC ≥80  
IP 65 30 000 h Pza. caj. 6

**TL-7125.BSENSDIM ATENUABLE**

SMD LED  
25 W 100 - 277 V~ FP 0.9  
4 000 K 3 200 lm IRC ≥80  
IP 65 30 000 h Pza. caj. 6

**TL-7131.B BLANCO**

SMD LED  
30 W 120 - 277 V~ FP 0.9  
4 000 K 3 750 lm IRC ≥80  
IP 65 30 000 h Pza. caj. 6

**TL-7131.BEMER BLANCO**

SMD LED  
30 W 120 - 277 V~ FP 0.9  
4 000 K 3 750 lm IRC ≥80  
IP 65 30 000 h Pza. caj. 6

**TL-7131.BSENS ON-OFF**

SMD LED  
30 W 120 - 277 V~ FP 0.9  
4 000 K 3 750 lm IRC ≥80  
IP 65 30 000 h Pza. caj. 6

**TL-7131.BSENSDIM ATENUABLE**

SMD LED  
30 W 100 - 277 V~ FP 0.9  
4 000 K 3 750 lm IRC ≥80  
IP 65 30 000 h Pza. caj. 6

\* Driver integrado.

\* Permiten el uso con sensor de movimiento SE-2101.B o SE-2102.B (Pág. 103).



## Luminarios LED de sobreponer |

Fabricados en policarbonato y PMMA



**TL-1835.B40 BLANCO**  
SMD LED  
36 W 100 - 277 V~ FP 0.5  
4 000 K 2 880 lm IRC ≥80  
IP 65 25 000 h Pza. caj. 20

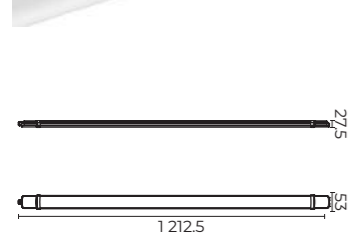

**TL-1835.B65 BLANCO**  
SMD LED  
36 W 100 - 277 V~ FP 0.5  
6 500 K 2 880 lm IRC ≥80  
IP 65 25 000 h Pza. caj. 20



**TL-7218.B40 BLANCO**  
T8 LED  
2×18 W 100 - 277 V~ FP 0.9  
4 000 K 3 400 lm IRC ≥80  
IP 65 15 000 h Pza. caj. 6

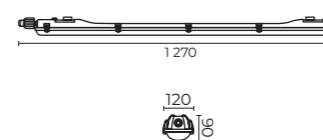

**TL-7218.B40SENS ON-OFF**  
T8 LED  
2×18 W 120 - 277 V~ FP 0.9  
4 000 K 3 400 lm IRC ≥80  
IP 65 15 000 h Pza. caj. 6

\* El sensor es externo.

**TL-7218.B65 BLANCO**  
T8 LED  
2×18 W 100 - 277 V~ FP 0.9  
6 500 K 3 400 lm IRC ≥80  
IP 65 15 000 h Pza. caj. 6

**TL-7218.B65SENS ON-OFF**  
T8 LED  
2×18 W 120 - 277 V~ FP 0.9  
6 500 K 3 200 lm IRC ≥80  
IP 65 15 000 h Pza. caj. 6

\* El sensor es externo.



**TL-7136.B BLANCO**  
SMD LED  
36 W 120 - 277 V~ FP 0.9  
4 000 K 3 716 lm IRC ≥80  
IP 65 35 000 h Pza. caj. 4

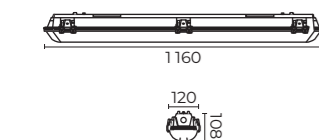

**TL-7136.BEMER BLANCO**  
SMD LED  
36 W 120 - 277 V~ FP 0.9  
4 000 K 3 716 lm IRC ≥80  
IP 65 35 000 h Pza. caj. 4

**TL-7136.BSENS ON-OFF**  
SMD LED  
36 W 120 - 277 V~ FP 0.9  
4 000 K 3 716 lm IRC ≥80  
IP 65 35 000 h Pza. caj. 4

**TL-7136.BSENSDIM ATENUABLE**  
SMD LED  
36 W 100 - 277 V~ FP 0.9  
4 000 K 3 716 lm IRC ≥80  
IP 65 35 000 h Pza. caj. 4



\* Driver integrado.  
\* Permiten el uso con sensor de movimiento SE-2101.B o SE-2102.B (Pág. 103).

## Luminarios Fluorescentes |

Fabricados en policarbonato



**TF-7125.B30 BLANCO**  
T5 Base G5  
25 W 100 - 277 V~ FP 0.98  
3 000 K 2 900 lm IRC ≥85  
IP 65 35 000 h Pza. caj. 9

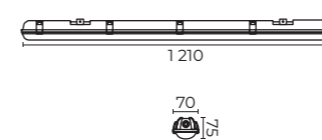

**TF-7125.B40 BLANCO**  
T5 Base G5  
25 W 100 - 277 V~ FP 0.98  
4 000 K 2 900 lm IRC ≥85  
IP 65 35 000 h Pza. caj. 9

**TF-7125.B65 BLANCO**  
T5 Base G5  
25 W 100 - 277 V~ FP 0.98  
6 500 K 2 900 lm IRC ≥85  
IP 65 35 000 h Pza. caj. 9

**TF-7125.BEMER BLANCO**  
T5 Base G5  
25 W 100 - 277 V~ FP 0.98  
3 000 K 2 900 lm IRC ≥85  
IP 65 35 000 h Pza. caj. 9



**TF-7225.B30 BLANCO**  
T5 Base G5  
2×25 W 100 - 277 V~  
FP 0.98 3 000 K 5 800 lm  
IRC ≥85 IP 65 35 000 h  
Pza. caj. 6

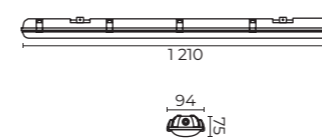

**TF-7225.B40 BLANCO**  
T5 Base G5  
2×25 W 100 - 277 V~  
FP 0.98 4 000 K 5 800 lm  
IRC ≥85 IP 65 35 000 h  
Pza. caj. 6

**TF-7225.B65 BLANCO**  
T5 Base G5  
2×25 W 100 - 277 V~  
FP 0.98 6 500 K 5 800 lm  
IRC ≥85 IP 65 35 000 h  
Pza. caj. 6

**TF-7225.BEMER BLANCO**  
T5 Base G5  
2×25 W 100 - 277 V~  
FP 0.98 3 000 K 5 800 lm  
IRC ≥85 IP 65 35 000 h  
Pza. caj. 6

\* Balastro integrado.  
\* Disponibles con batería de emergencia, agregando la terminación EMER. Por ejemplo (TF-7125.B30EMER).



**TF-7149.B30 BLANCO**  
T5 Base G5  
49 W 100 - 277 V~ FP 0.98  
3 000 K 5 000 lm IRC ≥85  
IP 65 40 000 h Pza. caj. 9

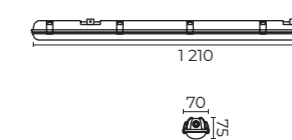

**TF-7149.B40 BLANCO**  
T5 Base G5  
49 W 100 - 277 V~ FP 0.98  
4 000 K 5 000 lm IRC ≥85  
IP 65 40 000 h Pza. caj. 9

**TF-7149.B65 BLANCO**  
T5 Base G5  
49 W 100 - 277 V~ FP 0.98  
6 500 K 5 000 lm IRC ≥85  
IP 65 40 000 h Pza. caj. 9

**TF-7149.BEMER BLANCO**  
T5 Base G5  
49 W 100 - 277 V~ FP 0.98  
3 000 K 5 000 lm IRC ≥85  
IP 65 40 000 h Pza. caj. 9



**TF-7249.B30 BLANCO**  
T5 Base G5  
2×49 W 100 - 277 V~  
FP 0.98 3 000 K 10 000 lm  
IRC ≥85 IP 65 40 000 h  
Pza. caj. 6

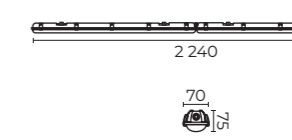

**TF-7249.B40 BLANCO**  
T5 Base G5  
2×49 W 100 - 277 V~  
FP 0.98 4 000 K 10 000 lm  
IRC ≥85 IP 65 40 000 h  
Pza. caj. 6

**TF-7249.B65 BLANCO**  
T5 Base G5  
2×49 W 100 - 277 V~  
FP 0.98 6 500 K 10 000 lm  
IRC ≥85 IP 65 40 000 h  
Pza. caj. 6

**TF-7249.BEMER BLANCO**  
T5 Base G5  
2×49 W 100 - 277 V~  
FP 0.98 3 000 K 10 000 lm  
IRC ≥85 IP 65 40 000 h  
Pza. caj. 6



# LUMINARIOS INDUSTRIALES |



PROYECTO: Bodega MER  
LUMINARIA: TL-8190.SR

Interior / Techo / Suspendido / LED

## Luminarios para alto montaje |

Cuerpo fabricado en lámina de acero



LED

**TL-8190.SR** BLANCO

SMD LED  
190 W 100 - 277 V~ FP 0,9  
4 100 K 1 500 lm IRC ≥80  
IP 20 30 000 h Pza. caj. 1

- \* No incluye sistema de suspensión.
- \* Driver integrado.
- \* Disponibles con batería de emergencia (**TL-8190.SREMER**).

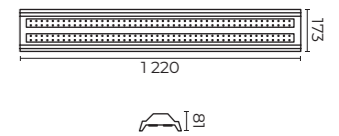

LED

**TL-8418.SR40** BLANCO

T8 LED  
4x18 W 100 - 277 V~ FP 0,9  
4 000 K 6 800 lm IRC ≥80  
IP 20 15 000 h Pza. caj. 1

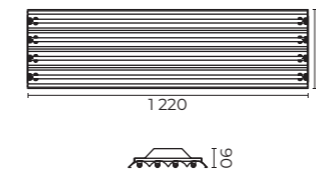

**TL-8418.SR65** BLANCO

SMD LED  
4x18 W 100 - 277 V~ FP 0,9  
6 500 K 6 800 lm IRC ≥80  
IP 20 15 000 h Pza. caj. 1

- \* Incluyen lámpara FL-10T8.18MV LED.
- \* No incluye sistema de suspensión.

LED

**TL-8618.SR** BLANCO

T8 LED  
6x18 W 100 - 277 V~ FP 0,9  
6 500 K 10 200 lm IRC ≥80  
IP 20 15 000 h Pza. caj. 1

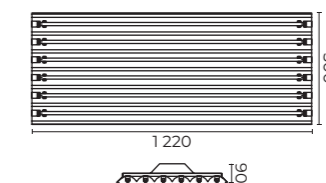

- \* Incluyen lámpara FL-10T8.18MV LED. Opción con difusor de acrílico.
- \* No incluye sistema de suspensión.



- \* No incluyen sistema de suspensión.
- \* Disponibles con batería de emergencia.
- \* Con opción a difusor de acrílico sobre pedido.

Interior / Techo / Suspendido / LED

## Luminarios para alto montaje |

Cuerpo fabricado en lámina de acero



LED

**TL-8080.SR BLANCO**

SMD LED  
84 W 120 - 277 V~  
4 100 K 13 200 lm IRC ≥80  
IP 20 50 000 h Pza. caj.1

\* No incluye sistema de suspensión.

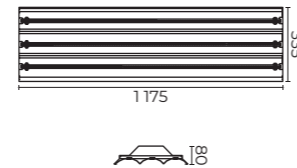

LED

**TL-8180.SR BLANCO**

SMD LED  
112 W 120 - 277 V~  
4 100 K 17 600 lm IRC ≥80  
IP 20 50 000 h Pza. caj.1

\* No incluye sistema de suspensión.

\* Incluyen driver y tablillas PHILIPS.

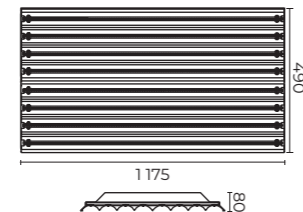

LED

**TL-8224.SR BLANCO**

SMD LED  
224 W 120 - 277 V~  
4 100 K 35 200 lm IRC ≥80  
IP 20 50 000 h Pza. caj.1

\* No incluye sistema de suspensión.

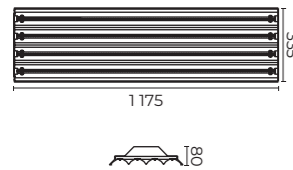

MONTAJE Y DIRECCIÓN DE LA LUZ



TL-8080  
TL-8180  
TL-8224

- \* Driver integrado.
- \* No incluyen sistema de suspensión.
- \* Disponibles con batería de emergencia.
- \* Con opción a difusor de acrílico sobre pedido.
- \* Pueden ajustarse a los lúmenes requeridos de acuerdo a las necesidades del área, sobre pedido.
- \* Disponibles con batería de emergencia, agregando la terminación EMER. Por ejemplo (TL-8080.SREMER).

Interior - Exterior / Techo / Suspendido / LED

## Luminarios Industrial LED |

Fabricados en aleación de magnesio con sistema de enfriamiento



LED

**TL-7100.NHB50120 NEGRO**

SMD LED 2835  
100 W 100 - 277 V~  
5 000 K 12 500 lm IRC ≥80  
IP 65

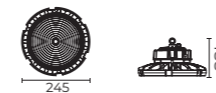

LED

**TL-7200.NHB50120 NEGRO**

SMD LED 2835  
200 W 100 - 277 V~  
5 000 K 25 000 lm IRC ≥80  
IP 65

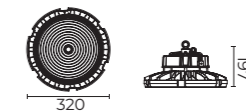

MONTAJE Y DIRECCIÓN DE LA LUZ



TL-7100  
TL-7150  
TL-7180

\* Driver incluido.

# LUMINARIOS DE INTERIOR PARA EMPOTRAR EN MURO |



PROYECTO: Corporativo CEO  
LUMINARIA: MH-4248.LED

Interior / Muro / Empotrar / LED

## Luminarios de cortesía LED |

Fabricados en aluminio con acabado satinado

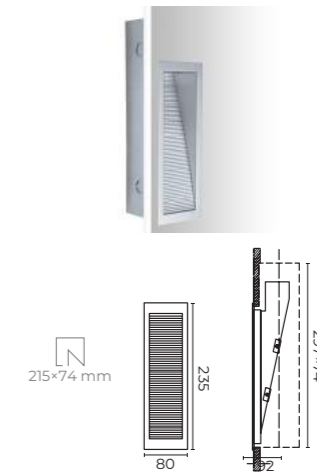

LED  
**MH-4248.LED SATÍN**  
LED  
5 W 100 - 240 V~ FP 0.5  
3 000 K 200 lm IRC ≥85  
IP 20 30 000 h Pza. caj. 12

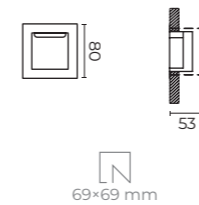

LED  
**MH-4239.BLED BLANCO**  
**MH-4239.LED SATÍN**  
LED  
4 W 100 - 240 V~ FP 0.5  
3 000 K 200 lm IRC ≥85  
IP 20 30 000 h Pza. caj. 50

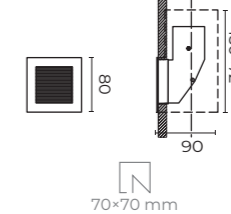

LED  
**MH-4247.LED SATÍN**  
LED  
5 W 100 - 240 V~ FP 0.5  
3 000 K 200 lm IRC ≥85  
IP 20 30 000 h Pza. caj. 18



\* Incluye driver integrado.

\* Permiten el uso con sensor de movimiento SE-2101.B o SE-2102.B (Pág. 103).

Interior / Muro / Empotrar / LED

## Luminarios de cortesía LED |

Fabricado en aluminio | fabricado en aleación de zinc | fabricado en aluminio y PMMA



LED  
**ML-2300.B** BLANCO  
**ML-2300.N** NEGRO  
LED  
1 W 100 - 277 V~ FP 0.5  
3 000 K 95 lm IRC ≥80  
IP 20 30 000 h  
Pza. caj. 100

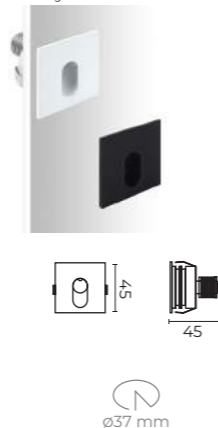

LED  
**ML-2301.B** BLANCO  
**ML-2301.N** NEGRO  
LED  
1 W 100 - 277 V~ FP 0.5  
3 000 K 95 lm IRC ≥80  
IP 20 30 000 h  
Pza. caj. 100

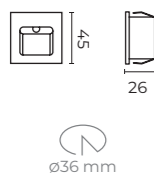

LED  
**ML-2302.B** BLANCO  
**ML-2302.N** NEGRO  
LED  
2x1 W 100 - 277 V~ FP 0.5  
3 000 K 180 lm IRC ≥80  
IP 20 30 000 h  
Pza. caj. 100

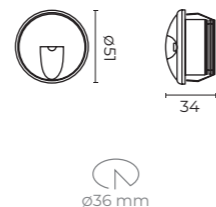

\* Driver remoto.  
\* Permiten el uso con sensor de movimiento SE-2101.B o SE-2102.B (Pág. 103).

Interior / Muro / Empotrar / LED

## Luminarios de cortesía LED |

Fabricado en aluminio y PMMA



LED  
**ML-2303.B** BLANCO  
**ML-2303.N** NEGRO  
LED  
3 W 100 - 277 V~ FP 0.5  
3 000 K 270 lm IRC ≥80  
IP 20 30 000 h Pza. caj. 50

\* Permiten el uso con sensor de movimiento SE-2101.B o SE-2102.B (Pág. 95).

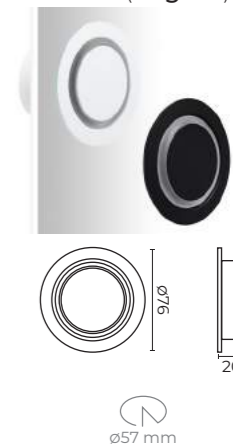

LED  
**ML-2305.BSENS** BLANCO  
**ML-2305.NSENS** NEGRO  
SMD LED  
3 W 100 - 277 V~ 50/60 Hz  
3 000 K 45 lm IRC ≥80  
IP 20 30 000 h Pza. caj.

\* Cuentan con sensor de movimiento integrado.  
\* Fabricado en ABS.

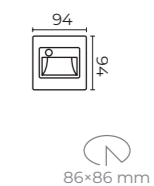

\* Driver remoto.

# LUMINARIOS DE INTERIOR PARA SOBREPONER EN MURO |



PROYECTO: Elevia Residencial  
LUMINARIA: ML-4601.N

Interior / Muro / Sobreponer/ LED

## Luminarios tipo arbotante LED |

Fabricados en aluminio



LED

**ML-4601.B** BLANCO

**ML-4601.N** NEGRO

SMD LED  
4.5 W 100 - 240 V~ FP 0.9  
2.700 K 240 lm IRC ≥85  
IP 20 30 000 h Pza. caj. 20

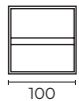
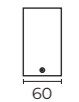

LED

**ML-4602.B** BLANCO

**ML-4602.N** NEGRO

SMD LED  
4.5 W 100 - 240 V~ FP 0.9  
2.700 K 200 lm IRC ≥85  
IP 20 30 000 h Pza. caj. 20

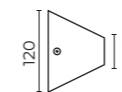

LED

**ML-4603.B** BLANCO

**ML-4603.N** NEGRO

SMD LED  
9 W 100 - 240 V~ FP 0.9  
2.700 K 820 lm IRC ≥85  
IP 44 30 000 h Pza. caj. 20



\* Driver integrado.

\* Permiten el uso con sensor de movimiento SE-2101.B o SE-2102.B (Pág. 103).

Interior / Muro / Sobreponer / LED

## Luminarios tipo arbotante LED |

Fabricados en aluminio

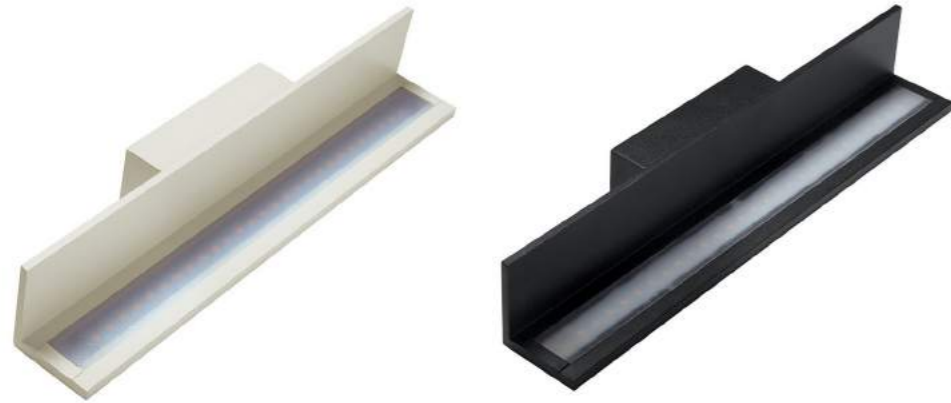

LED

**ML-4605.B** BLANCO  
**ML-4605.N** NEGRO

SMD LED  
9 W 100 - 240 V~ FP 0.9  
2 700 K 960 lm IRC ≥85  
IP 44 30 000 h Pza. caj. 20

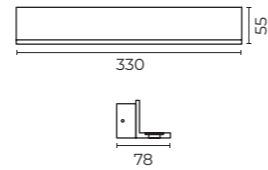

LED

**ML-4606.B** BLANCO  
**ML-4606.N** NEGRO

SMD LED  
4.5 W 100 - 240 V~ FP 0.9  
2 700 K 100 lm IRC ≥85  
IP 20 30 000 h Pza. caj. 20

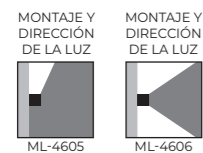
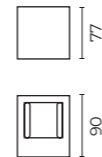

\* Driver integrado.  
\* Permiten el uso con sensor de movimiento SE-2101.B o SE-2102.B (Pág. 103).

Interior / Muro / LED

## Luminarios para lectura |

Fabricados en aluminio



LED

**ML-3603.N27LEC** NEGRO

SMD LED  
3 W 100 - 240 V~ FP 0.45  
3 000 K 240 lm IRC ≥80  
IP 20 40 000 h Pza. caj. 50

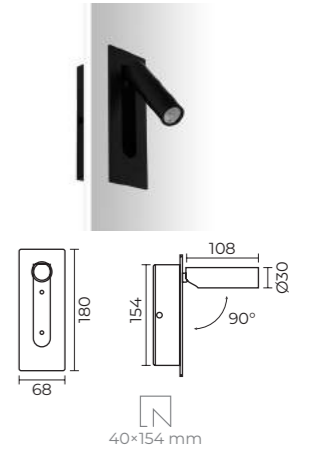

LED

**PL-4801.B** ALUMINIO

SMD LED  
1 W 127 V~  
3 000 K 100 lm IRC ≥80  
IP 20 30 000 h Pza. caj. 50

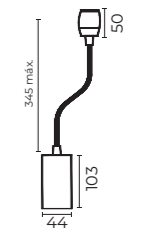

\* Driver integrado.

## Tira de LED SMD 5630 |

Con funda impermeable de silicón



LED

### ML-0563.BC30KIT

SMD LED 5630  
9 W /m -270 W (Total)  
127 V~ 3 000 K FP 0.95  
700 lm/m - 21 000lm (Total)  
IRC ≥80 IP 54 30 000 h  
Pza. caj. 1

\* Corte cada 500 mm

### ML-0563.BF30KIT

SMD LED 5630  
9 W /m -270 W (Total)  
127 V~ 4 000 K FP 0.95  
700 lm/m - 21 000lm (Total)  
IRC ≥80 IP 54 30 000 h  
Pza. caj. 1

\* Corte cada 500 mm

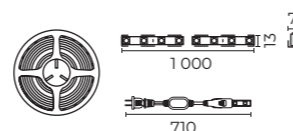

#### ACCESORIOS

• (3) AC127-DC127

Convertidor de corriente.



• (5) CD-0001

Conector



• (90) CLIP-TL

Clip para fijar.



#### ACCESORIOS

• (10) LED CAP

Tapa final.



- \* El Kit contiene:
- 1 carrete de tira LED de 30 m
- 3 convertidores AC127-DC127
- 5 conectores CD-0001
- 90 clips CLIP-TL
- 10 tapas finales LED CAP

\* Alto voltaje con funda impermeable de silicón para sobreponer en muro o techo. Uso interior y exterior. 60 LED/m.  
\* Accesorios se pueden vender por separado.



## Tira de LED con sensor de movimiento |

Con funda impermeable de silicón



LED

### ML-2701.BCSE

SMD LED  
12 W (Total) 100 - 277 V~  
2 200 K IRC ≥80  
Ángulo de detección 120°  
IP 44 50 000 h Pza. caj. 20

\* Corte cada 500 mm

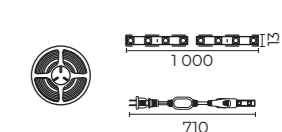

#### ACCESORIOS

• (1) INTERRUPTOR DE ENERGÍA

(A)



• (1) CABLE Y

(B)



• (2) SENSORES DE MOVIMIENTO

(C)



- \* El Kit contiene:
- 1 Interruptor de energía (A).
- 1 Cable Y de 2 m (B).
- 2 Sensores de movimiento (C).
- 2 Tiras LED de 1.5 m cada una.

\* El sensor puede ajustarse de acuerdo a las necesidades requeridas. La tira puede permanecer encendida de 5 a 120 segundos, dependiendo del tiempo programado. Puede controlarse el nivel de sensibilidad y los luxes en el área para que deje de operar.





Interior / Muro / Sobreponer / LED

## Accesorio para Tira de LED |

Fabricado en aluminio y acero



### KITML-1220.N *NEGRO*

Montaje de sobreponer  
Medidas de base  
120x130mm  
IP 20 Uso interior

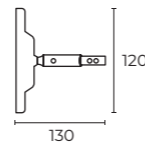
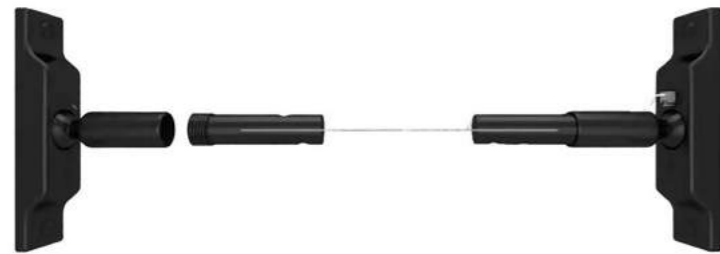

\* Accesorio se vende por separado.

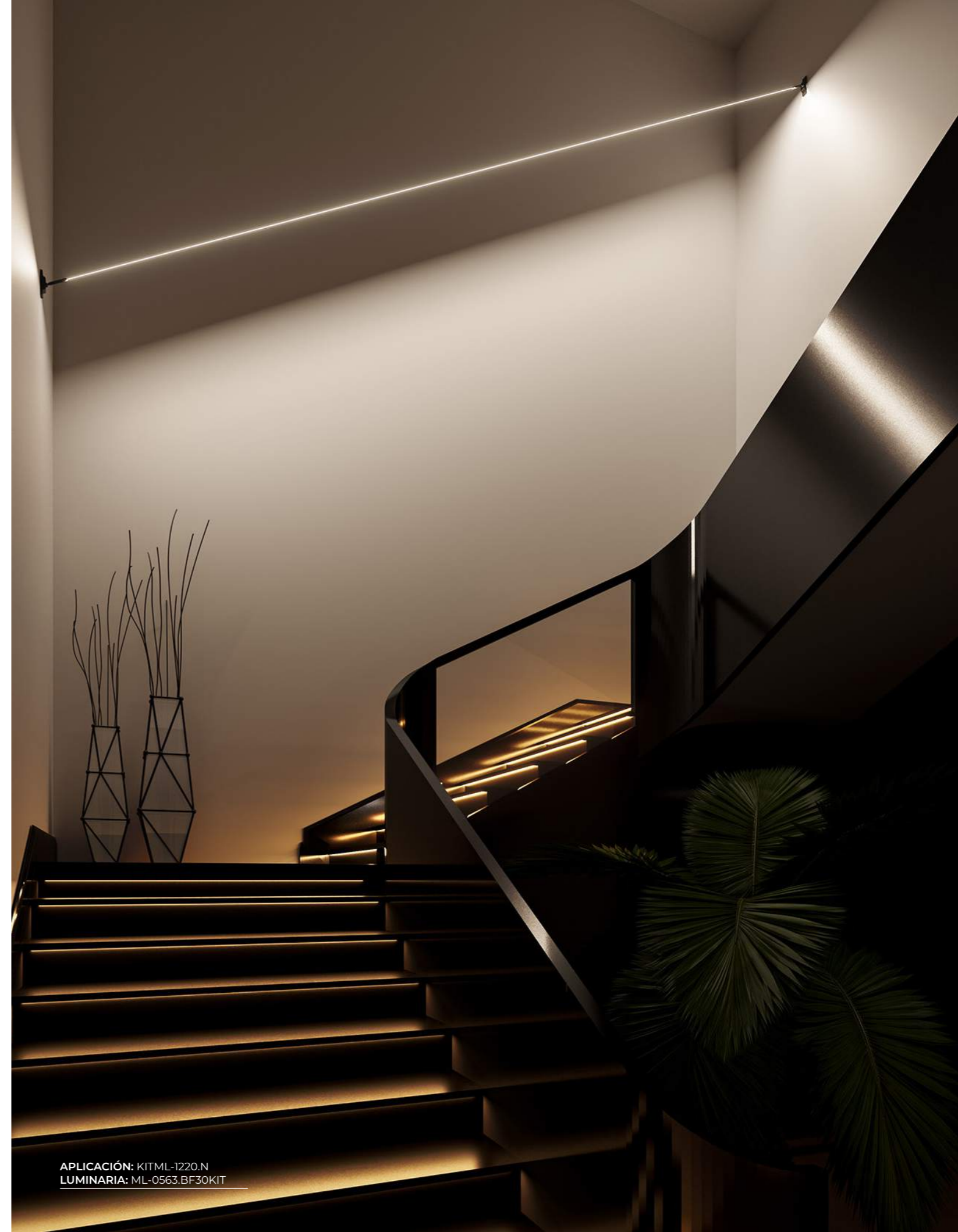

APLICACIÓN: KITML-1220.N  
LUMINARIA: ML-0563.BF30KIT

# LUMINARIOS PARA INTERIOR DE EMERGENCIA |



Interior / Emergencia / LED

## Luminarios LED de emergencia |

Inyección ABS termoplástico

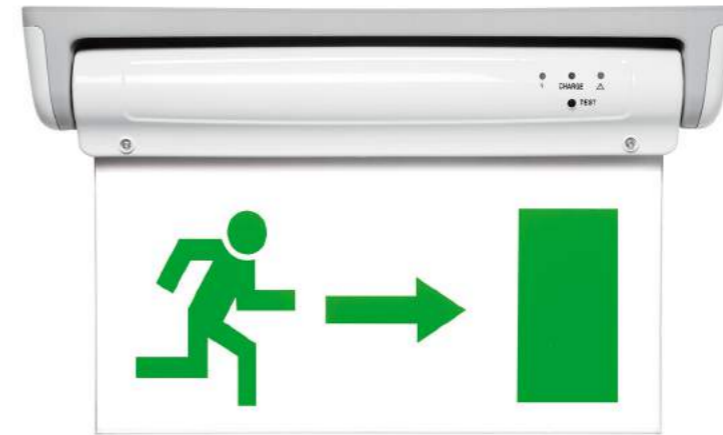

LED

**SL-1602.EMER BLANCO**

LED  
2.1 W 100 - 277 V~  
IP 20 50 000 h Pza. caj. 10

\* Se puede empotrar, sobreponer o suspender en techo o muro. Incluye driver.

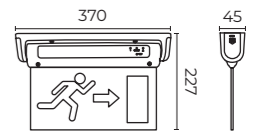

LED

**ML-1703.EMER BLANCO**

LED  
5 W 127 V~  
4 100 K 200 lm  
IP 20 50 000 h Pza. caj. 20

\* Con tiempo de operación en modo de emergencia: 8 horas en intensidad baja y 4 horas en máxima intensidad.  
\* Recargable y portátil.

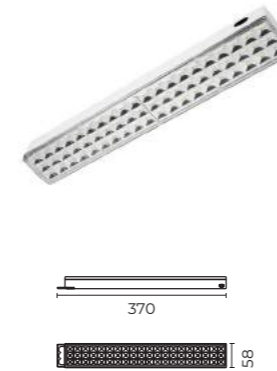

LED

**ML-1601.EMER BLANCO**

LED  
2x1.2 W 120 V~ | 277 V~  
4 100 K 275 lm IRC ≥82  
IP 20 50 000 h Pza. caj. 6

\* Incluye cables para los 2 voltajes).  
\* Incluye driver.  
\* Placa universal para rápida instalación.



# EXTRACTORES DE AIRE PARA INTERIOR |



PROYECTO: Residencial WTC  
 PRODUCTO: VT-1906.B

## Interior / Ventilación

### Extractores de aire cuadrados |

Fabricados en plástico ABS



·VT-1904.B



#### VT-1904.B BLANCO

Ducto 4" (100 mm)  
 12 W 110 V~ Ruido 39 dB  
 Flujo de aire 90 m<sup>2</sup>/H  
 Área aplicable 4 a 7 m<sup>2</sup>  
 IP 44 Pza. caj. 20

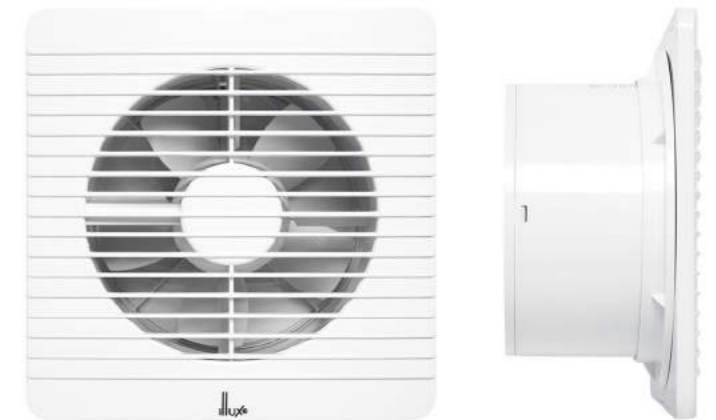
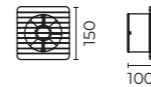

·VT-1906.B



#### VT-1906.B BLANCO

Ducto 6" (150 mm)  
 17 W 110 V~ Ruido 39 dB  
 Flujo de aire 192 m<sup>2</sup>/H  
 Área aplicable 7 a 10 m<sup>2</sup>  
 IP 44 Pza. caj. 18

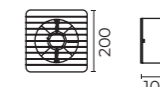

#### nuevo

#### VT-1914.B BLANCO

Ducto 4" (100 mm)  
 GU10 LED (No incluida)  
 10 W 110 V~ Ruido 45 dB  
 Flujo de aire 66 m<sup>2</sup>/H  
 Área aplicable 4 a 7 m<sup>2</sup>  
 IP 44 Pza. caj. 20



\* Cuentan con una trampilla de retención para evitar lluvia, polvo y olores cuando no se encuentran encendidos.

# SENSORES |



PROYECTO: Centro Holístico Buena Vida  
SENSOR: SE-2102.B

## Interior / Sensores

### Sensores de movimiento y fotocelda |

Fabricados en PC

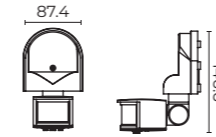

#### SE-2101.B BLANCO

800 W Incandescentes  
200 W LED  
Consumo aproximado 0.5 W  
110 - 130 V~  
Luz ambiental <3-2 000 LUX  
(ajustable)  
Rango de detección 180°  
Pza. caj. 50



#### SE-2102.B BLANCO

800 W Incandescentes  
200 W LED  
Consumo aproximado 0.5 W  
110 - 130 V~  
Luz ambiental <3-2 000 LUX  
(ajustable)  
Rango de detección 360°  
Pza. caj. 50

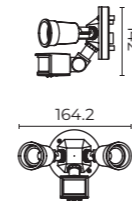

#### SE-2103.B BLANCO

2x150 W  
Consumo aproximado 0.5 W  
110 - 130 V~  
Luz ambiental <3-2 000 LUX  
(ajustable)  
Rango de detección 180°  
Pza. caj. 20

\* Sugerencia de lámpara:  
FL-10A19.930 (Pág. 89) o  
FL-10A19.965 (Pág. 89)  
Modelos PAR20, PAR30  
y PAR38 Illux.

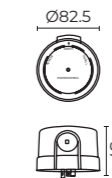

#### FC-2104.S FOTOCELDA

800 W máx.  
Consumo aproximado 0.5 W  
110 - 240 V~  
Luz ambiental <5 - 15 LUX  
Pza. caj. 100

\* Fotocelda, permite controlar la luz de la luminaria detectando la luz ambiental. Ideal para luminarios viales.

#### ACCESORIO (NO INCLUIDO)

• FC-2104.SAcc  
Base para fotocelda.



SE-2103

- \* Fáciles de instalar.
- \* Operan con lámparas LED, Fluorescentes y halógenas.
- \* Con detector de sensibilidad y circuito integrado. Identifican la noche y el día automáticamente.

## Sensor ON - OFF |

Fabricados en policarbonato

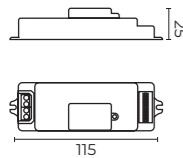

Potencia máxima para LED y fluorescentes: 400 W  
Potencia máxima para incandescente: 800 W

### SE-7000 ON - OFF

Encendido y apagado automático basado en el movimiento y en el nivel de luz.

Su tamaño compacto lo hace adecuado para fijarse con la mayoría de los luminarios.

4 presas de poste en el terminal (L, N, N, L), fácil de ensamblar.

El detector de área, el temporizador y el umbral de la luz del día se pueden establecer con precisión a través del switch DIP.

120 - 277 V~  
50/60 Hz IP 20

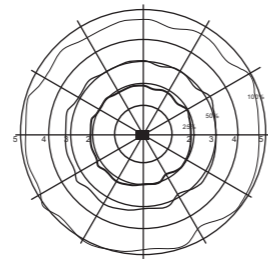

Patrón de montaje de techo (Unidad: m)  
Altura de instalación sugerida: 2.5-6m

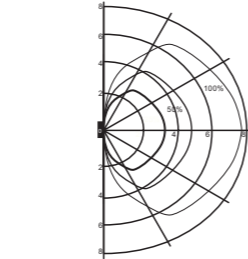

Patrón de montaje de detección (Unidad: m)  
Altura de instalación sugerida: 1-1.8 m

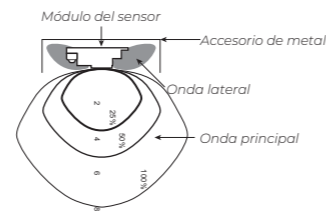

### SENSOR DE MOVIMIENTO + DRIVER LED O BALASTRO

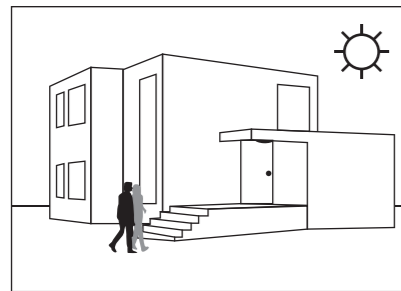

Con luz suficiente la lámpara no enciende.

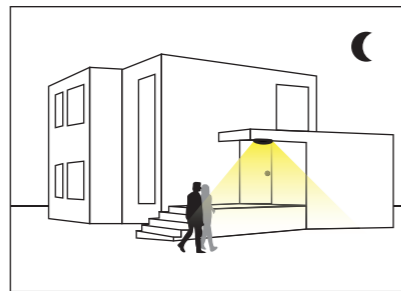

Con luz ambiente insuficiente, el sensor enciende la lámpara cuando el movimiento es detectado.

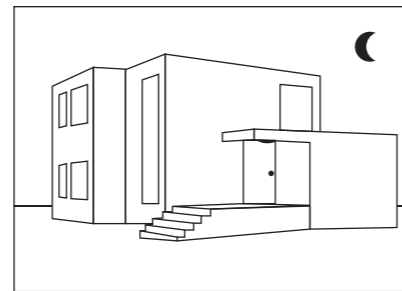

Después de un tiempo de espera, el sensor apaga la lámpara cuando no hay movimiento detectado.

\* Se venden por separado o integrado a los luminarios (consultar modelos).

## Sensor Atenuable |

Fabricados en policarbonato

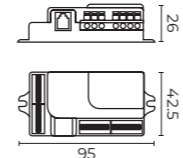

Potencia máxima para LED y fluorescentes: 400 W  
Potencia máxima para incandescente: 800 W

### SE-7002 ATENUABLE

Atenuación automática cuando se usa en combinación con drivers LED atenuables o balastos de 1 - 10 V~.

Cuenta con sensor de luz diurna ajustable.

El área de detección, el retraso de tiempo y el umbral de luz natural pueden ser configurado con precisión a través del interruptor DIP.

Usando el diseño separado entre el sensor de movimiento y la corriente, lo hace fácil de reinstalar o ajustar.

120 - 277 V~  
50/60 Hz IP 20

### PATRÓN DE DETECCIÓN

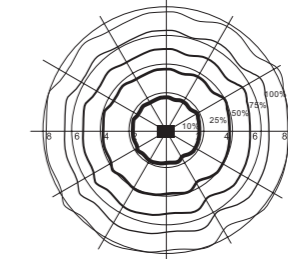

Patrón de montaje de techo (Unidad: m)  
Altura de instalación sugerida: 2.5-8m

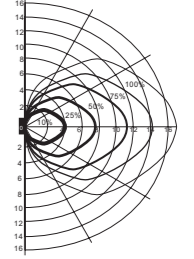

Patrón de montaje de detección (Unidad: m)  
Altura de instalación sugerida: 1-1.8 m

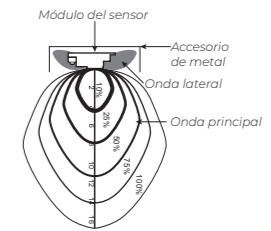

### FUNCIÓN DE ATENUACIÓN

Cuando se utiliza en combinación con drivers LED y balastos atenuables de 1 - 10 V~, el sensor puede trabajar 3 modos. Función de atenuación, 100% a luz baja y luz baja a apagado. El sensor SE-7002 sensible a los cambios de luz, es fácil de instalar y muy rentable.

Además, el sensor puede proporcionar una función de atenuación en 2 pasos. 100% → poca luz (nunca se apaga). Este modo es adecuado para su uso en corredores, escaleras y pasajes subterráneos donde se mantienen bajos niveles de luz hasta que se detecta movimiento.

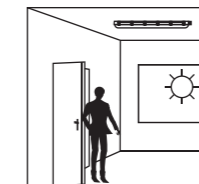

1. Con suficiente luz ambiental el sensor no enciende la luminaria.

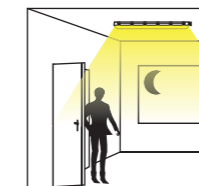

2. Cuando la luz ambiental es insuficiente, el sensor enciende la luminaria cuando detecta movimiento.

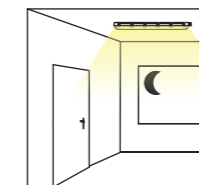

1. Sin detectar movimiento, el luminario mantiene una iluminación tenue.

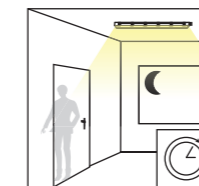

3. Después de mantener un tiempo la intensidad de la luz, el sensor retorna a la atenuación inicial, si no detecta movimiento.

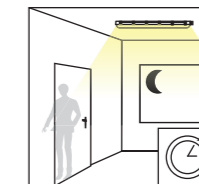

3. Después de un tiempo, el sensor atenúa la luz de la luminaria siempre y cuando el sensor no detecte movimiento.

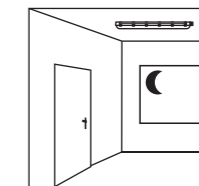

4. Después de un periodo de espera, el sensor apaga la luminaria de no capta movimiento en el área de detección.

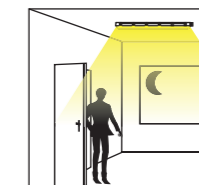

2. Cuando el sensor detecta movimiento, aumenta el brillo del luminario a un 100%

\* Se venden por separado o integrado a los luminarios (consultar modelos).

## Sensor Atenuable |

Fabricado en policarbonato

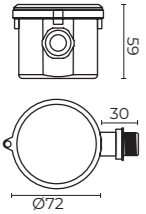

Potencia máxima para LED y fluorescentes: 400 W  
Potencia máxima para incandescente: 800 W

### SE-7004 ATENUABLE

Atenuación automática de 1 - 10 V~ cuando se usa en combinación con drivers LED o balastos.

Cuenta con sensor de luz diurna ajustable.

Amplia área de detección, con alcance de hasta 16m de diámetro y altura de montaje 15m. máx. adecuado para el uso de almacén.

Cuenta con diferentes soportes para realizar montajes de diversa índole.

120 - 277 V~  
50/60 Hz IP 65

### PATRÓN DE DETECCIÓN

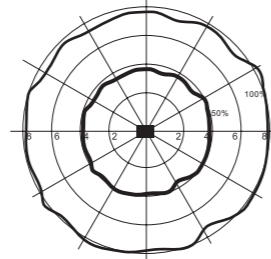

Patrón de montaje de techo (Unidad: m)  
Altura de instalación sugerida: 2.5-8m

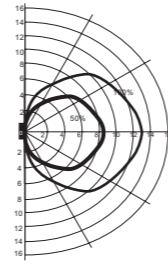

Patrón de montaje de detección (Unidad: m)  
Altura de instalación sugerida: 1-18 m

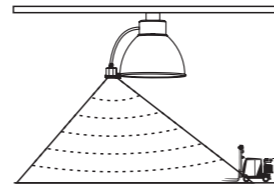
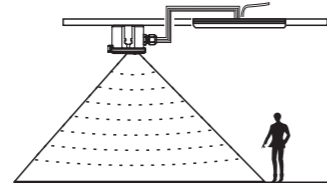

### FUNCIÓN DE ATENUACIÓN

Cuando se utiliza en combinación con drivers LED y balastos atenuables de 1 - 10 V~, el sensor puede trabajar 3 pasos. Función de atenuación, 100% a luz baja y de luz baja a apagado. El sensor SE-7004 puede incorporar sensores de luz diurna sensibles a los cambios de luz. Es fácil de instalar y muy rentable.

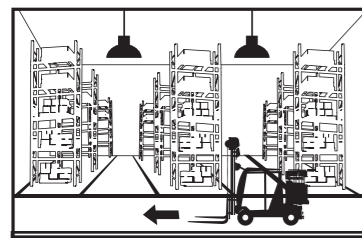

1. Con suficiente luz ambiental el sensor no enciende la luminaria.

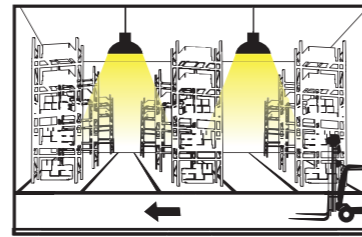

2. Cuando la luz ambiental es insuficiente, el sensor enciende la luminaria cuando detecta movimiento.

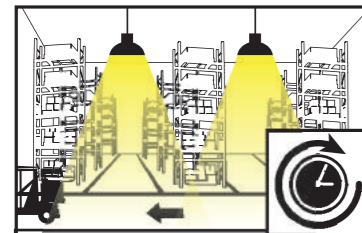

3. Después de un tiempo, el sensor atenúa la luz de la luminaria siempre y cuando el sensor no detecte movimiento.

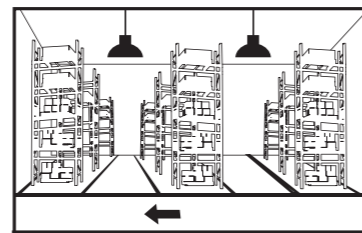

4. Después de un periodo de espera, el sensor apaga la luminaria de no capta movimiento en el área de detección.

\* Se venden por separado o integrado a los luminarios (consultar modelos).

## Sensor Atenuable |

Fabricado en policarbonato



PROYECTO: Town Square Metepec  
LUMINARIA: TL-7125.B

### CONTROL REMOTO PARA SE-7004 ATENUABLE



Descripción	Nombre			
25% / 50% / 75% / 100%	Área de detección			
El tiempo de espera desde 100% hasta la atenuación 8s / 1 min / 5 min / 15 min / 30 min	Tiempo de espera			
5 Lux / 15 Lux / 50 Lux / 150 Lux / desactivado	Umbral de luz de día			
Siempre en modo ON/OFF	ON/OFF			
Presione el botón "Reinicio" sólo para la configuración de fábrica.	Reinicio			
Área de detección	Tiempo de espera			
Sensor de luz de día	Periodo de espera			
Porcentaje de atenuación				
100 %	1 min	Disable	3 min	20 %
4 configuraciones rápidas opcionales	1/2/3/4			

Nombre	Descripción
Transmisión	Carga los ajustes
Periodo de espera	Tiempo de espera desde la atenuación hasta apagar 0s / 1 min / 5 min / 30 min / +
Nivel de espera atenuable	10% / 20% / 30% / 40% / 50%
Modo automático	A. Área de detección de movimiento: 3-6 m B. Detección de presencia: 3-6 m C. Detección de presencia con captación de luz diurna: 3-6 m D. Altura de montaje: 6-15 m E. Alto montaje con aprovechamiento diurno: 6-15 m
Atenuable + / Atenuable -	Ajustar el nivel de luz cuando se detecta movimiento.
Umbral ambiental	Presione este botón para establecer el umbral de luz de día adecuado actual.

\* Control remoto se vende por separado.

# LÁMPARAS |

Interior / Lámparas

## Lámparas LED |

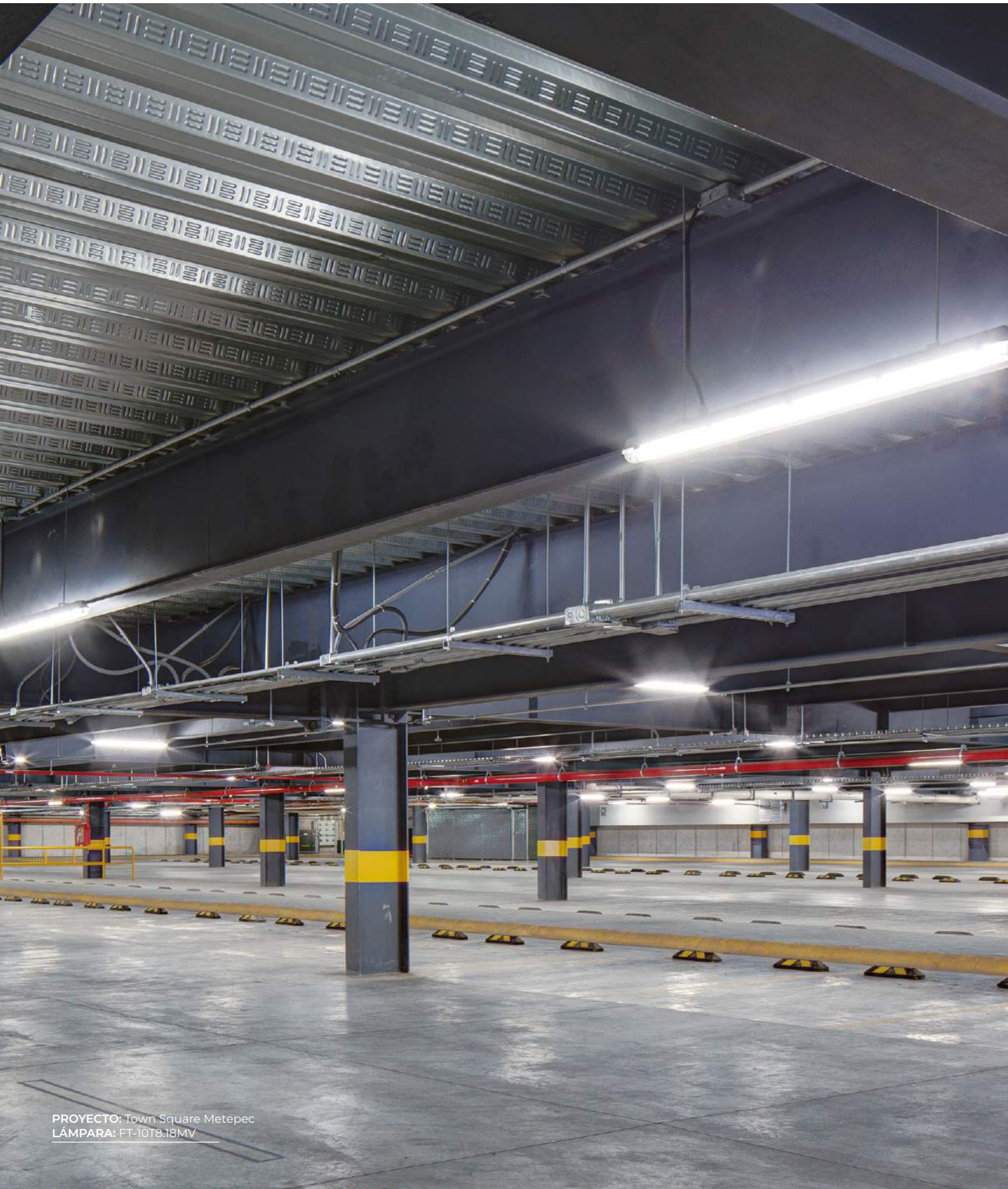

PROYECTO: Town Square Metepec  
LÁMPARA: FT-10T8.18MV

### LED

#### FL-10T8.18MV *BLANCO*

T8 Base G13  
18 W 100 - 277 V~  
Equivalencia fluorescente  
32 W  
Ángulo 300° 4 000 K  
1 700 lm IRC ≥80 FP 0.92  
15 000 h Pza. caj. 25

#### FL-10T8.18MV60 *BLANCO*

T8 Base G13  
18 W 100 - 277 V~  
Equivalencia fluorescente  
32 W  
Ángulo 300° 6 500 K  
1 700 lm IRC ≥80 FP 0.92  
15 000 h Pza. caj. 25

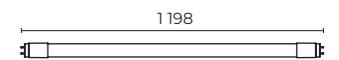

⊙=G13

\*Se alimenta de un solo lado.



### LED

#### FL-10A19.KIT30 *BLANCO*

(4) A19 Base E26  
60 W 100 - 240 V~ FP 0.9  
3 000 K 800 lm IRC ≥80  
150° 15 000 h Pza. caj. 12

#### FL-10A19.KIT65 *BLANCO*

(4) A19 Base E26  
60 W 100 - 240 V~ FP 0.9  
6 500 K 800 lm IRC ≥80  
150° 15 000 h Pza. caj. 12



\* No requieren driver.

\* Nuestras lámparas cuentan con certificación **NOM**.

## Lámparas LED |



LED

### FL-10GU10.527 BLANCO

Atenuable GU10  
Base GU10 6 W 120 V~  
Equivalencia incandescente  
50 W Ángulo 38° 2 700 K  
500 lm IRC ≥80 FP 0.9  
15 000 h Pza. caj. 24



### FL-10GU10.530 BLANCO

Atenuable GU10  
Base GU10 6 W 120 V~  
Equivalencia incandescente  
50 W Ángulo 38° 3 000 K  
500 lm IRC ≥80 FP 0.9  
15 000 h Pza. caj. 24

### FL-10GU10.565 BLANCO

Atenuable GU10  
Base GU10 6 W 120 V~  
Equivalencia incandescente  
50 W Ángulo 38° 6 500 K  
500 lm IRC ≥80 FP 0.9  
15 000 h Pza. caj. 24



LED

### FL-10MR16.530 BLANCO

MR16 Base GU5.3  
4.5 W 100 - 240 V~  
Equivalencia incandescente  
35 W  
Ángulo 38° 3 000 K  
350 lm IRC ≥80 FP 0.5  
15 000 h Pza. caj. 24



### FL-10MR16.540 BLANCO

MR16 Base GU5.3  
4.5 W 100 - 240 V~  
Equivalencia incandescente  
35 W  
Ángulo 38° 4 000 K  
350 lm IRC ≥80 FP 0.5  
15 000 h Pza. caj. 24

## Fuentes de Poder LED |



LED

### TL-4008.G27 GRIS

LED COB  
Sustituye MR16  
10 W 100 - 277 V~  
Ángulo 24° | 38° | 60°  
2 700 K 895 lm  
IRC ≥90 30 000 h



### TL-4008.G30 GRIS

LED COB  
Sustituye MR16  
10 W 100 - 277 V~  
Ángulo 24° | 38° | 60°  
3 000 K 895 lm  
IRC ≥90 30 000 h

### TL-4008.G40 GRIS

LED COB  
Sustituye MR16  
10 W 100 - 277 V~  
Ángulo 24° | 38° | 60°  
4 000 K 895 lm  
IRC ≥90 30 000 h

TL-4008.G27(XX°)D GRIS

TL-4008.G30(XX°)D GRIS

TL-4008.G40(XX°)D GRIS

100 - 120 V~



LED

### TL-4115.G27 GRIS

LED COB  
Sustituye AR111  
15 W 100 - 277 V~  
Ángulo 15° | 24°  
2 700 K 1 400 lm  
IRC ≥90 30 000 h



### TL-4115.G30 GRIS

LED COB  
Sustituye AR111  
15 W 100 - 277 V~  
Ángulo 15° | 24°  
3 000 K 1 400 lm  
IRC ≥90 30 000 h

### TL-4115.G40 GRIS

LED COB  
Sustituye AR111  
15 W 100 - 277 V~  
Ángulo 15° | 24°  
4 000 K 1 400 lm  
IRC ≥90 30 000 h

TL-4115.G27(XX°)D GRIS

TL-4115.G30(XX°)D GRIS

TL-4115.G40(XX°)D GRIS

100 - 120 V~

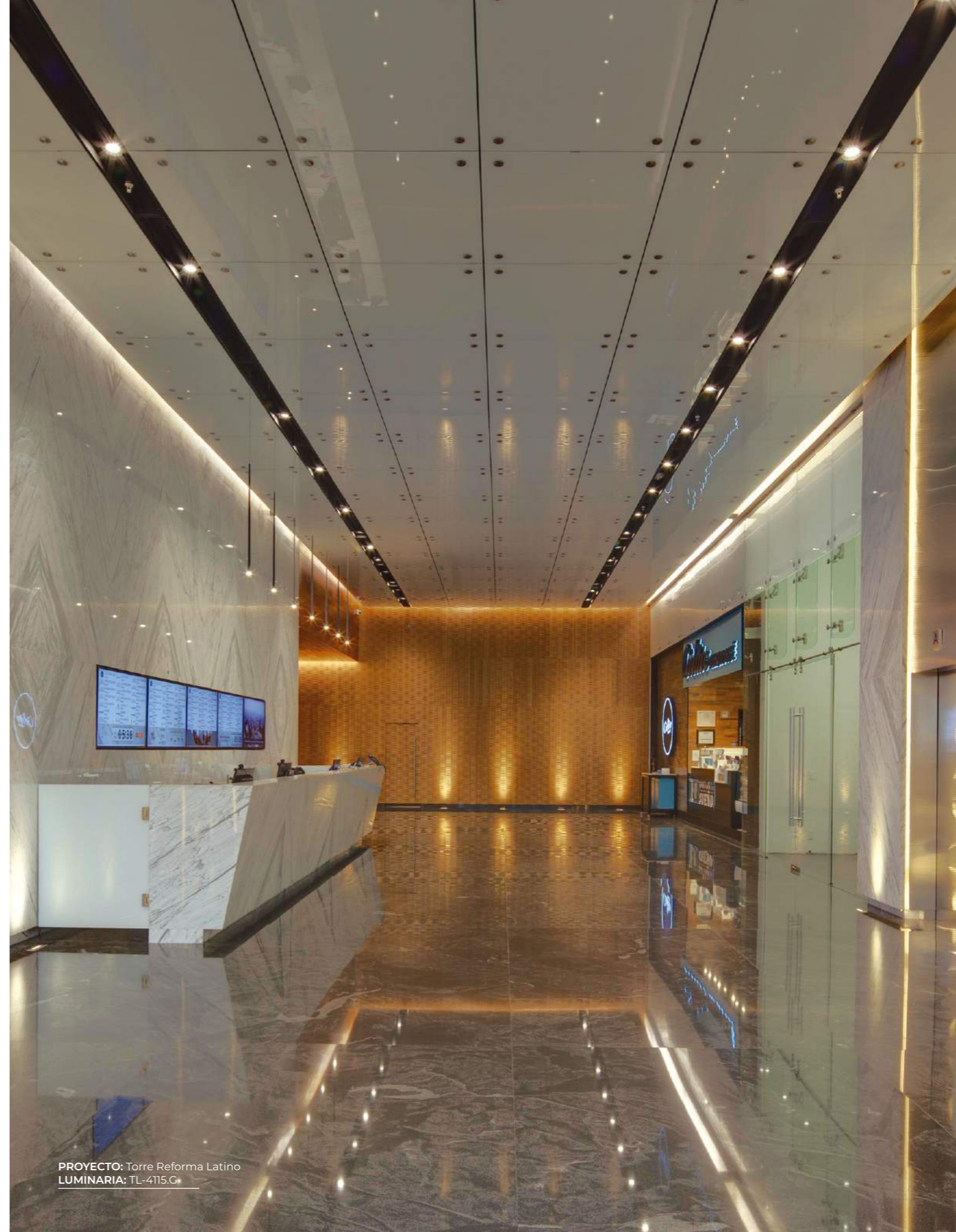

\* No requieren driver.

\* Nuestras lámparas cuentan con certificación





# EXTERIOR

-  Soporta humedad
-  Soporta polvo y agua
- LED** Tecnología LED
-  Tecnología Solar

\* Nuestros productos cuentan con certificación **NOM**.

\* Las medidas de los esquemas están en mm.

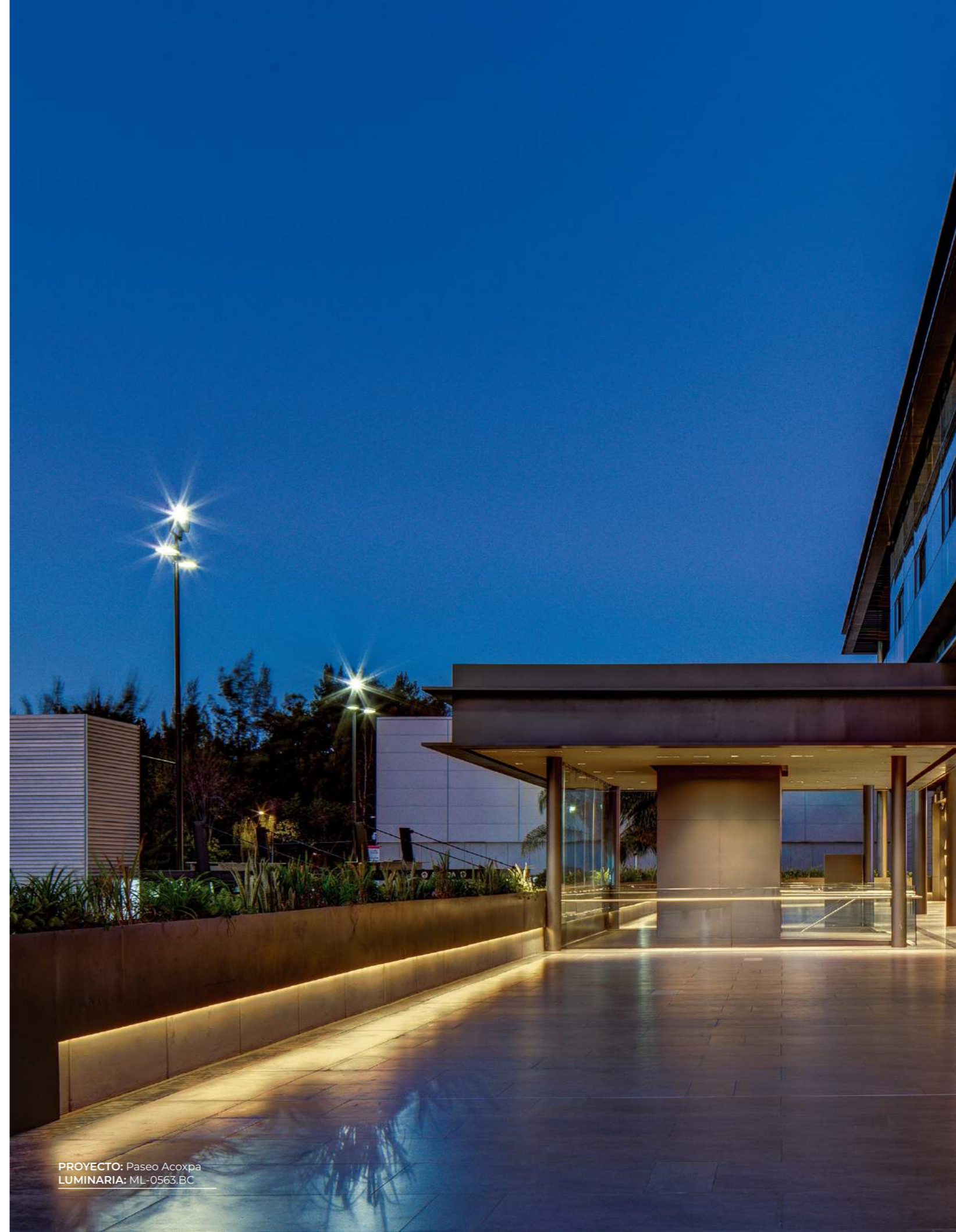

PROYECTO: Paseo Acoxpa  
LUMINARIA: ML-0563.BC

# LUMINARIOS DE EXTERIOR PARA EMPOTRAR EN PISO |



Exterior / Piso / Empotrar / LED

## Luminarios LED |

Fabricados en aluminio



LED  
**TL-5408.A27 ALUMINIO**  
 1 LED  
 1.1 W 110 - 277 V~  
 3 000 K 110 lm IRC ≥85  
 30° IP 65 30 000 h  
 Pza. caj. 4

**TL-5408.A41 ALUMINIO**  
 1 LED  
 1.1 W 110 - 277 V~  
 5 000 K 110 lm IRC ≥85  
 30° IP 65 30 000 h  
 Pza. caj. 4

\* Sobre pedido  
 Color del LED ■ ■ ■ ■  
 \* Óptica: 10°, 30° y 60°  
 \* Óptica esmerilada  
 \* Óptica asimétrica o elíptica  
 \* Acabado en color negro  
 \* Atenuable 110 V~ a 12 V~.



LED  
**PL-5205.A27 ALUMINIO**  
 4 LED  
 8 W 110 - 277 V~  
 3 000 K 720 lm IRC ≥85  
 30° IP 65 30 000 h  
 Pza. caj. 1

**PL-5205.A41 ALUMINIO**  
 4 LED  
 8 W 110 - 277 V~  
 5 000 K 720 lm IRC ≥85  
 30° IP 65 30 000 h  
 Pza. caj. 1

\* Sobre pedido  
 Color del LED ■ ■ ■ ■  
 \* Óptica: 10°, 30° y 60°  
 \* Óptica esmerilada  
 \* Óptica asimétrica o elíptica  
 \* Acabado en color negro  
 \* Atenuable 110 V~ a 12 V~.



LED  
**PL-5207.A27 ALUMINIO**  
 4 LED  
 5 W 110 - 277 V~  
 3 000 K 440 lm IRC ≥85  
 30° IP 65 30 000 h  
 Pza. caj. 1

**PL-5207.A41 ALUMINIO**  
 4 LED  
 5 W 110 - 277 V~  
 5 000 K 440 lm IRC ≥85  
 30° IP 65 30 000 h  
 Pza. caj. 1

\* Sobre pedido  
 Color del LED ■ ■ ■ ■  
 \* Óptica: 10°, 30° y 60°  
 \* Óptica esmerilada  
 \* Óptica asimétrica o elíptica  
 \* Acabado en color negro  
 \* Atenuable 110 V~ a 12 V~.

ACCESORIO PARA MODELO TL-5408 (NO INCLUIDO)

• H-5408  
 Housing para TL-5408



ACCESORIO PARA MODELO PL-5205 (NO INCLUIDO)

• H-5205  
 Housing para PL-5205



ACCESORIO PARA MODELO PL-5207 (NO INCLUIDO)

• H-5207  
 Housing para PL-5207



\* Accesorios se venden por separado.

Exterior / Piso / Sobreponer | Empotrar / LED

## Luminarios LED |

Fabricados en aluminio

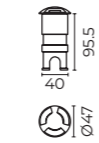
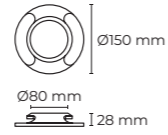

nuevo  LED

**PL-5003.A30 ALUMINIO**

LED  
4 W 90 - 277 V~ FP 0.85  
3 000 K 520 lm IP 65

**PL-5003.N30 NEGRO**

LED  
4 W 90 - 277 V~ FP 0.85  
3 000 K 520 lm IP 65

 LED

**PL-2303.S SATÍN**

LED  
1×3 W 100 - 277 V~ FP 0.5  
3 000 K 270 lm IRC ≥80  
IP 54 30 000 h Pza. caj. 50



PL-5003  
PL-2303

\* Driver incluido.

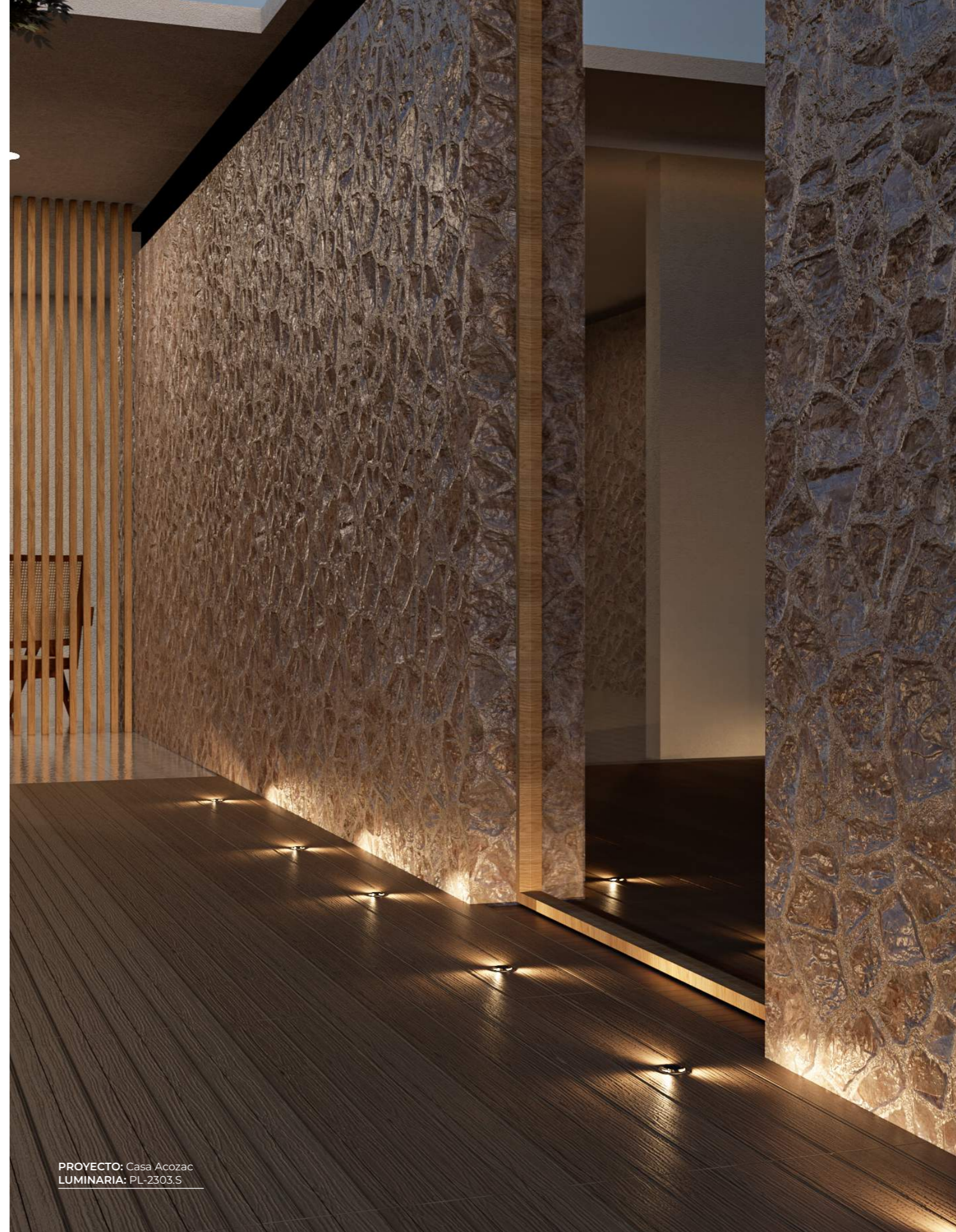

PROYECTO: Casa Acozac  
LUMINARIA: PL-2303.S

## LUMINARIOS DE EXTERIOR PARA SOBREPONER EN PISO |



PROYECTO: Centro cultural el dorado  
LUMINARIA: PS-4301.N

Exterior / Piso / Sobreponer / LED

### Luminario solar tipo bolardo |

Fabricados en aluminio



LED

PS-4301.N *NEGRO*

SMDLED  
1.5 W máx.  
Panel solar 5 V<sub>m</sub> / 2 W  
Batería Li-on 3.7 V<sub>m</sub>  
2 200 mAh  
Carga en soleado 6 - 8 h  
Detección 360° / 2 - 6 m  
3 000 K 420 lm  
IP 54 Pza. caj. 1

\* Incluye dos modos de trabajo inteligentes:  
· 100% de brillo con presencia, 20% de brillo sin presencia.  
· 100% de brillo con presencia, se apaga sin presencia.

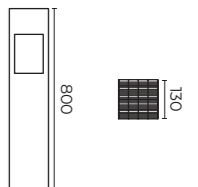

- \* De fácil instalación.
- \* No requiere alimentación. No consumen electricidad.
- \* Incluye panel solar de la más alta calidad y batería recargable.

119

## Luminarios bolardo |

Fabricados en aluminio

LED

**PL-4503.C GRIS**

LED  
3.3 W 100 - 240 V~  
3 000 K 260 lm FP 0.5  
IP 65 30 000 h Pza. caj. 8

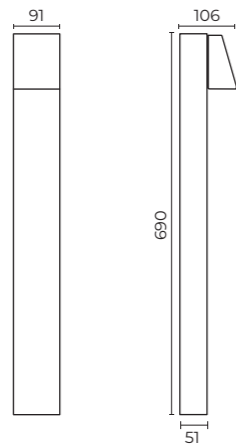

LED

**PL-4504.C GRIS**

LED  
3.3 W 100 - 240 V~  
3 000 K 260 lm FP 0.5  
IP 65 30 000 h Pza. caj. 8

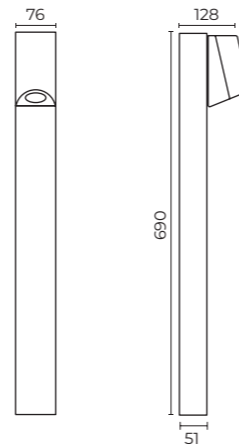

LED

**PL-4505.C GRIS**

LED  
2x3.3 W 100 - 240 V~  
3 000 K 520 lm FP 0.5  
IP 65 30 000 h Pza. caj. 8

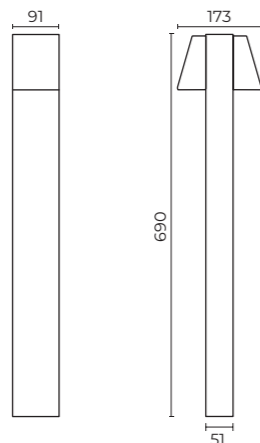

LED

**PL-4506.C GRIS**

LED  
2x3.3 W 100 - 240 V~  
3 000 K 520 lm FP 0.5  
IP 65 30 000 h Pza. caj. 8

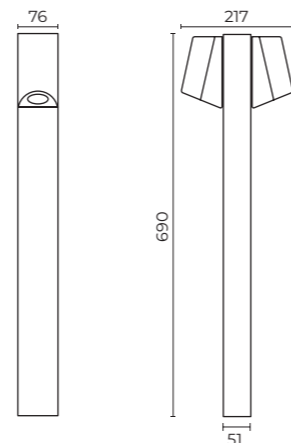

\* Driver integrado.

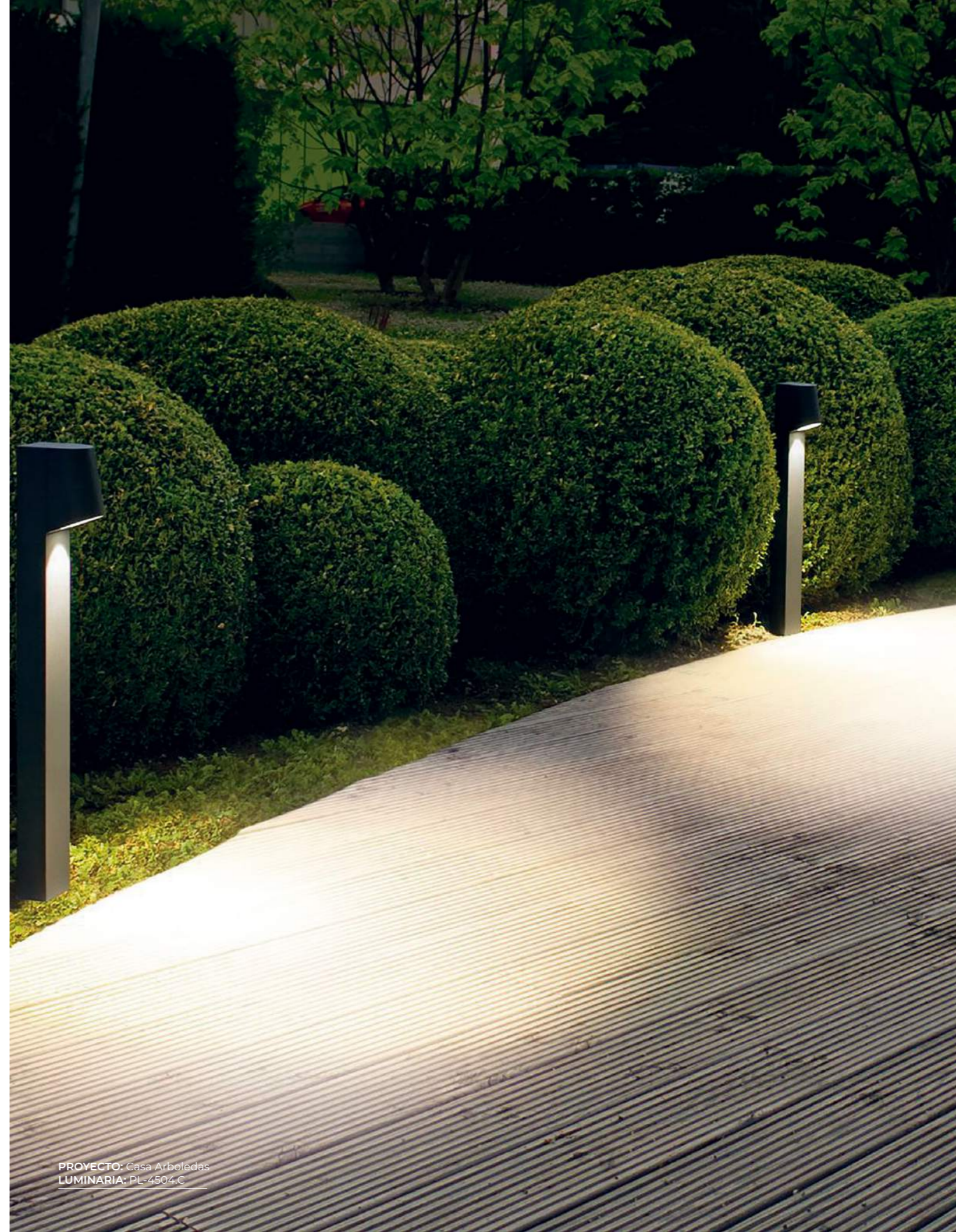

PROYECTO: Casa Arboledas  
LUMINARIA: PL-4504.C

## Luminarios LED tipo reflector |

Fabricados en aluminio



·RL-3610.N



·RL-3630.N



·RL-3650.N



·RL-36100.N

## Luminarios LED tipo reflector |

Fabricados en aluminio



LED

### RL-3610.N30 NEGRO

SMD LED  
10 W 100 - 277 V~ FP 0,9  
3 000 K 1 000 lm IRC ≥80  
IP 65 30 000 h Pza. caj. 20

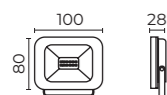

### RL-3610.N65 NEGRO

SMD LED  
10 W 100 - 277 V~ FP 0,9  
6 500 K 1 000 lm IRC ≥80  
IP 65 30 000 h Pza. caj. 20



LED

### RL-3630.N30 NEGRO

SMD LED  
30 W 100 - 277 V~ FP 0,9  
3 000 K 3 000 lm IRC ≥80  
IP 65 30 000 h Pza. caj. 10

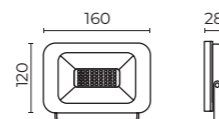

### RL-3630.N65 NEGRO

SMD LED  
30 W 100 - 277 V~ FP 0,9  
6 500 K 3 000 lm IRC ≥80  
IP 65 30 000 h Pza. caj. 10



LED

### RL-3650.N30 NEGRO

SMD LED  
50 W 100 - 277 V~ FP 0,9  
3 000 K 5 000 lm IRC ≥80  
IP 65 30 000 h Pza. caj. 10

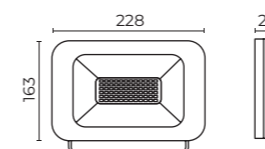

### RL-3650.N65 NEGRO

SMD LED  
50 W 100 - 277 V~ FP 0,9  
6 500 K 5 000 lm IRC ≥80  
IP 65 30 000 h Pza. caj. 10



LED

### RL-36100.N30 NEGRO

SMD LED  
100 W 100 - 277 V~ FP 0,9  
3 000 K 10 000 lm IRC ≥80  
IP 65 30 000 h Pza. caj. 5

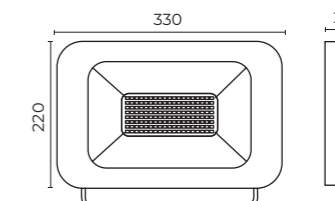

### RL-36100.N65 NEGRO

SMD LED  
100 W 100 - 277 V~ FP 0,9  
6 500 K 10 000 lm IRC ≥80  
IP 65 30 000 h Pza. caj. 5

MONTAJE Y DIRECCIÓN DE LA LUZ



RL-3601  
RL-3630

- \* Driver integrado.
- \* Permiten el uso con sensor de movimiento SE-2101.B o SE-2102.B (Pág. 103).
- \* Permiten el uso con fotocelda FC-2104.S (Pág. 103).

MONTAJE Y DIRECCIÓN DE LA LUZ



RL-3650  
RL-36100

- \* Driver integrado.
- \* Permiten el uso con sensor de movimiento SE-2101.B o SE-2102.B (Pág. 103).
- \* Permiten el uso con fotocelda FC-2104.S (Pág. 103).

Exterior / Piso / Sobreponer / LED

## Luminarios LED tipo reflector |

Fabricados en aluminio



nuevo  LED

**RL-36200.N30** NEGRO

SMD LED  
200 W 100 - 277 V~  
3 000 K 18 000 lm IRC ≥80  
IP 65 30 000 h

**RL-36200.N65** NEGRO

SMD LED  
200 W 100 - 277 V~  
6 500 K 18 000 lm IRC ≥80  
IP 65 30 000 h

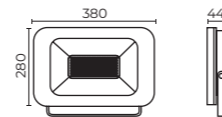

- \* Driver integrado.
- \* Permiten el uso con sensor de movimiento SE-2101.B o SE-2102.B (Pág. 103).
- \* Permiten el uso con fotocelda FC-2104.S (Pág. 103).



PROYECTO: Universidad Alamedas  
LUMINARIA: RL-36200.N65

# LUMINARIOS DE EXTERIOR PARA EMPOTRAR EN MURO |



PROYECTO: Casa Santa Bárbara  
LUMINARIA: ML-3702.A

Exterior / Muro / Empotrar / LED

## Luminarios LED |

Fabricados en acero inoxidable con difusor de acrílico



ML-3701.A



ML-3702.A

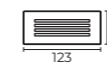

LED

**ML-3701.A ALUMINIO**

LED SMD 2835  
1.5 W 100 - 277 V~ FP 0.5  
3 000 K 92 lm IRC ≥80  
IP 65 30 000 h  
Pza. caj. 100

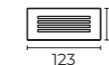

LED

**ML-3702.A ALUMINIO**

LED SMD 2835  
1.5 W 100 - 277 V~  
3 000 K 47 lm IRC ≥80  
IP 65 30 000 h  
Pza. caj. 100



\* Driver integrado.



# LUMINARIOS DE EXTERIOR PARA SOBREPONER EN MURO |



PROYECTO: Casa Huxquilucan  
LUMINARIA: MS-3105.N

Exterior / Muro / Sobreponer / LED

## Luminarios solares LED |

Fabricados en ABS



nuevo LED

MS-3104.N NEGRO

LED Bridgelux  
2.5 W máx.  
Panel solar 4.8 V<sub>m</sub> / 0.9 W  
Batería litio 3.7 VCD  
Carga en soleado 6 - 8 h  
Detección 120°  
6 000 K 400 lm  
IP 65 Pza. caj. 48

- \* Modos de trabajo:
- Micro + inducción: 100% de luz con presencia / Luz tenue sin presencia
  - Inducción: 100% de luz con presencia / apagado sin presencia
  - Luz permanente: 100% luz con o sin presencia
  - Luz emergencia: 100% de luz durante 240 min.

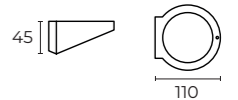

nuevo LED

MS-3105.N NEGRO

LED Bridgelux  
6 W máx.  
Panel solar 5 V<sub>m</sub> / 2.5W  
Batería LiFePo4 3.2 VCD  
Carga en soleado 6 - 8 h  
Detección 180°  
6 000 K 800 lm  
IP 65 Pza. caj. 40

- \* Modos de trabajo:
- Micro + inducción: 100% de luz con presencia / Luz tenue sin presencia
  - Inducción: 100% de luz con presencia / apagado sin presencia
  - Luz permanente: 100% luz con o sin presencia
  - Luz emergencia: 100% de luz durante 240 min.

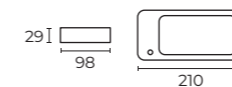

MONTAJE Y DIRECCIÓN DE LA LUZ

MS-3104  
MS-3105  
MS-3106



nuevo LED

MS-3106.N NEGRO

LED  
6 W máx.  
Panel solar 5 V<sub>m</sub> / 3.5W  
Batería LiFePo4 3.2 VCD  
Carga en soleado 6 - 8 h  
Detección 180°  
6 000 K 800 lm  
IP 65 Pza. caj. 20

- \* Encendido automático al detectar oscuridad y apagado automático al detectar la luz.

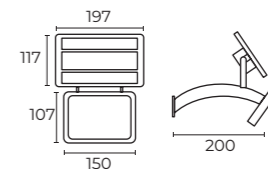

- \* De fácil instalación.
- \* No requieren alimentación. No consumen electricidad.
- \* Incluyen panel solar de la más alta calidad y batería recargable.

## Luminarios LED |

Fabricados en aluminio con pantalla de policarbonato opalino



·ML-3706.G



·ML-3707.G



LED

**ML-3706.G GRIS**

LED SMD 2835  
6 W 100 - 277 V~ FP 0.5  
3 000 K 130 lm IRC ≥80  
IP 54 30 000 h Pza. caj. 18

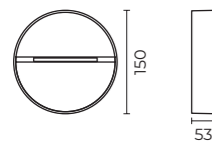

LED

**ML-3707.G GRIS**

LED SMD 2835  
6 W 100 - 277 V~ FP 0.5  
3 000 K 130 lm IRC ≥80  
IP 54 30 000 h Pza. caj. 18

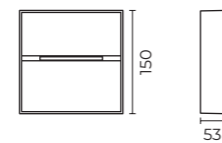

MONTAJE Y DIRECCIÓN DE LA LUZ



ML-3706  
ML-3707

\* Driver integrado.

\* Permiten el uso con sensor de movimiento SE-2101.B o SE-2102.B (Pág. 103).

## Luminarios de cortesía |

Fabricados en aluminio



LED

**MH-4253.A ALUMINIO**

MR16 MR16 LED  
(No incluida)  
Base GU5.3  
50 W 127 V~  
IP 54 Pza. caj. 18

\* Sugerencia de lámpara:  
FL-10MR16.530, de 3 000 K o  
FL-10MR16.540, de 4 000 K.

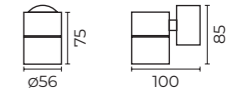

LED

**EL-4501.C GRIS**

LED  
3.3 W 100 - 240 V~  
3 000 K 400 lm IRC ≥80  
IP 64 30 000 h Pza. caj. 20

\* Driver integrado.

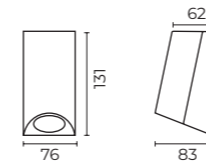

LED

**EL-4502.C GRIS**

LED  
3.3 W 100 - 240 V~  
3 000 K 400 lm IRC ≥80  
IP 64 30 000 h Pza. caj. 20

\* Driver integrado.

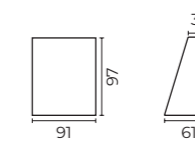

MONTAJE Y DIRECCIÓN DE LA LUZ



MH-4253  
EL-4501  
EL-4502

Exterior / Muro / Sobreponer / LED

## Luminarios decorativos |

Fabricados en aluminio

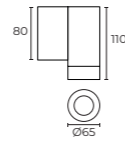

nuevo  LED

MH-6135.B BLANCO

MH-6135.N NEGRO

GU10 (No incluida)  
Base GU10  
35 W máx. 100 - 240 V~  
IP 65 Pza. caj. 20

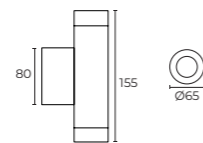

nuevo  LED

MH-6136.B BLANCO

MH-6136.N NEGRO

GU10 (No incluida)  
Base GU10  
2x35 W máx. 100 - 240 V~  
IP 65 Pza. caj. 20



\* Sugerencia de lámpara GU10 LED atenuable FL-10GU10.527 de 2 700 K, FL-10GU10.530 de 3 000 K o FL-10GU10.565 de 6 500 K (Pág. 110).

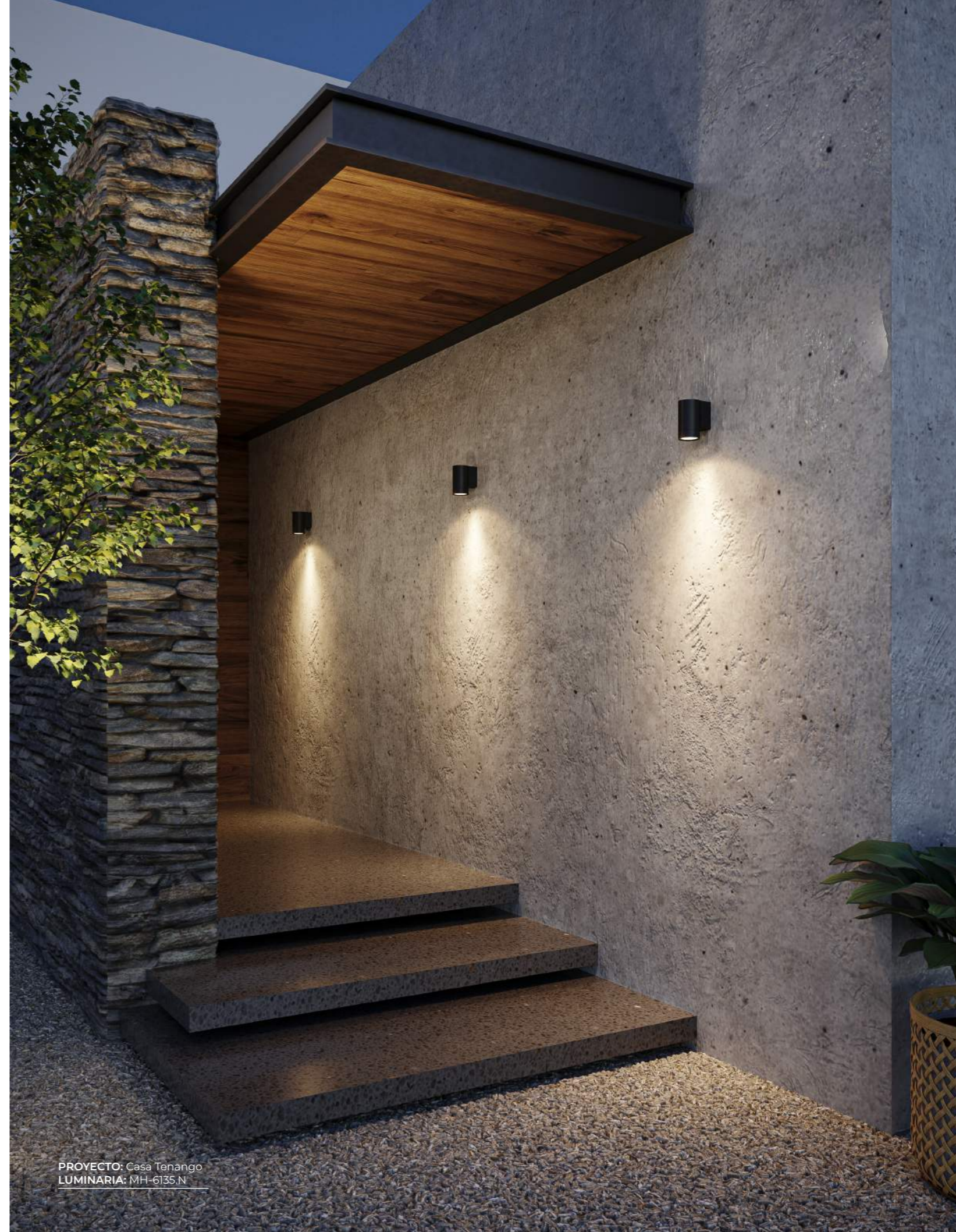

PROYECTO: Casa Tenango  
LUMINARIA: MH-6135.N

Exterior / Muro / Sobreponer / LED

## Luminarios de cortesía |

Fabricados en aluminio



LED

### ML-2304.B BLANCO

LED  
3 W 100 - 277 V~ FP 0.5  
3 000 K 270 lm IRC ≥80  
IP 54 30 000 h Pza. caj. 50



LED

### ML-2304.N NEGRO

LED  
3 W 100 - 277 V~ FP 0.5  
3 000 K 270 lm IRC ≥80  
IP 54 30 000 h Pza. caj. 50



MONTAJE Y DIRECCIÓN DE LA LUZ  
ML-2304

\* Incluye driver remoto.

Exterior / Muro / Sobreponer / LED

## Luminario de sobreponer |

Fabricado en PC



LED

### TL-7130.B BLANCO

SMD LED  
30 W 100 - 277 V~ FP 0.9  
4 000 K 2 550 lm IRC ≥80  
IP 66 40 000 h Pza. caj. 8

### TL-7130.BEMER BLANCO

90 min de luz.  
SMD LED  
30 W 100 - 277 V~ FP 0.9  
4 000 K 2 550 lm IRC ≥80  
IP 66 40 000 h Pza. caj. 8

\* Disponibles con sensor de movimiento integrado SE-7000 (TL-7130.BSENS) (TL-7130.BEMERSENS) o atenuable SE-7002 (TL-7130.SENSDIM) sobre pedido.

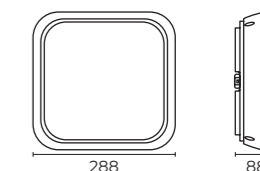

LED

### ML-7114.N NEGRO

LED  
14 W 100 - 277 V~ FP 0.9  
4 000 K 1 190 lm IRC ≥80  
IP 66 30 000 h Pza. caj. 8

### ML-7114.NEMER NEGRO

90 min de luz.  
LED  
14 W 100 - 277 V~ FP 0.9  
4 000 K 1 190 lm IRC ≥80  
IP 66 30 000 h Pza. caj. 8

\* Disponibles con sensor de movimiento integrado SE-7000 (ML-7114.NSENS) o atenuable SE-7002 (ML-7114.NSENSDIM).



MONTAJE Y DIRECCIÓN DE LA LUZ  
TL-7130  
ML-7114

\* Driver integrado.

\* Permiten el uso con sensor de movimiento SE-2101.B o SE-2102.B (Pág. 103).

# LUMINARIOS URBANOS VIALES |



PROYECTO: Town Square Metepec  
LUMINARIA: PL-2501.N

Exterior / Urbano Vial / LED

## Luminarios tipo poste |

Fabricados en aluminio con difusor de policarbonato

LED

### PL-2501.N NEGRO

T8 LED Base G13  
3x18 W 100 - 277 V~ FP 0.92  
4 000 K 5 100 lm IRC ≥80  
IP 54 25 000 h Pza. caj. 1  
Placa 19 cm Ancla 3/4"

### PL-2501.N65 NEGRO

T8 LED Base G13  
3x18 W 100 - 277 V~ FP 0.92  
6 500 K 5 100 lm IRC ≥80  
IP 54 25 000 h Pza. caj. 1  
Placa 19 cm Ancla 3/4"

### PL-2501.P PLATA

T8 LED Base G13  
3x18 W 100 - 277 V~ FP 0.92  
4 000 K 5 100 lm IRC ≥80  
IP 54 25 000 h Pza. caj. 1  
Placa 19 cm Ancla 3/4"

### PL-2501.P65 PLATA

T8 LED Base G13  
3x18 W 100 - 277 V~ FP 0.92  
6 500 K 5 100 lm IRC ≥80  
IP 54 25 000 h Pza. caj. 1  
Placa 19 cm Ancla 3/4"

\* Incluye lámpara Illux T8,  
FL-10T818.MV a 100 - 277 V~.

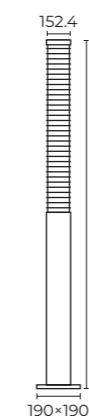

LED

### PL-2502.N26 NEGRO

### PL-2502.P26 PLATA

T8 LED Base G13  
3x10 W 100 - 277 V~ FP 0.9  
4 000 K 2 400 lm IRC ≥80  
IP 54 25 000 h Pza. caj. 1  
Placa 19 cm Ancla 3/4"  
Altura 2 600 mm

### PL-2502.N36 NEGRO

### PL-2502.P36 PLATA

T8 LED Base G13  
3x10 W 100 - 277 V~ FP 0.9  
4 000 K 2 400 lm IRC ≥80  
IP 54 25 000 h Pza. caj. 1  
Placa 19 cm Ancla 3/4"  
Altura 3 600 mm

\* Incluye lámpara.

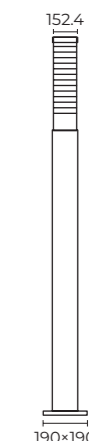

\* Incluyen ancla, placa y bastones para montaje.

Exterior / Urbano Vial / LED

## Luminarios para poste |

Fabricados en aluminio con difusor de policarbonato



LED  
**EL-7130.PC GRIS**  
LED  
30 W 100 - 277 V~ FP 0.9  
5 000 K 2 550 lm IRC ≥80  
IP 65 30 000 h Pza. caj. 66

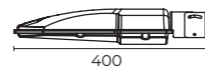

- \* Driver integrado.
- \* Cuerpo ligero, resistente a la corrosión, agua y polvo.

Exterior / Urbano Vial / LED

## Luminarios para poste |

Fabricados en aluminio con difusor de policarbonato



LED  
**EL-2635.G40 GRIS**  
LED  
20 W 120 - 277 V~ FP 0.95  
4 000 K 2 200 lm IRC ≥80  
IP 66 100 000 h Pza. caj. 1

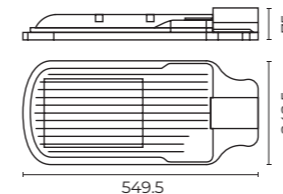

**EL-2635.G57 GRIS**  
LED  
35 W 120 - 277 V~ FP 0.9  
5 700 K 2 200 lm IRC ≥80  
IP 66 100 000 h Pza. caj. 1

**EL-2650.G40 GRIS**  
LED  
50 W 120 - 277 V~ FP 0.95  
4 000 K 5 500 lm IRC ≥80  
IP 66 100 000 h Pza. caj. 1

**EL-2650.G57 GRIS**  
LED  
50 W 120 - 277 V~ FP 0.95  
5 700 K 5 500 lm IRC ≥80  
IP 66 100 000 h Pza. caj. 1

**EL-2670.G40 GRIS**  
LED  
70 W 120 - 277 V~ FP 0.95  
4 000 K 7 700 lm IRC ≥80  
IP 66 100 000 h Pza. caj. 1



- \* Resistentes al alto impacto.
- \* Incluyen lámpara y driver PHILIPS.

LED  
**EL-2670.G57 GRIS**  
LED  
70 W 120 - 277 V~ FP 0.95  
5 700 K 7 700 lm IRC ≥80  
IP 66 100 000 h Pza. caj. 1

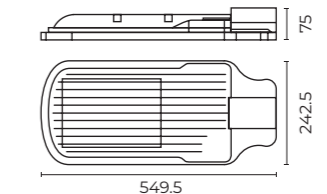

**EL-26100.G40 GRIS**  
LED  
100 W 120 - 277 V~ FP 0.95  
4 000 K 11 000 lm IRC ≥80  
IP 66 100 000 h Pza. caj. 1

**EL-26100.G57 GRIS**  
LED  
100 W 120 - 277 V~ FP 0.95  
5 700 K 11 000 lm IRC ≥80  
IP 66 100 000 h Pza. caj. 1

**EL-26146.G40 GRIS**  
LED  
150 W 120 - 277 V~ FP 0.95  
4 000 K 16 500 lm IRC ≥80  
IP 66 100 000 h Pza. caj. 1

**EL-26146.G57 GRIS**  
LED  
150 W 120 - 277 V~ FP 0.95  
5 700 K 16 500 lm IRC ≥80  
IP 66 100 000 h Pza. caj. 1

# LUMINARIOS DECORATIVOS MARCA KARTELL |



LUMINARIA: BIG FL/Y

## Techo / Suspender

### Luminarios decorativos |

fabricado en tecnopolímero termoplástico | fabricados en PMMA



- IL-9054.B4 Transparente
- IL-9054.K2 Azul nube
- IL-9054.K1 Azul petroleo
- IL-9054.K9 Verde salvia
- IL-9054.K6 Amarillo
- IL-9054.K4 Naranja
- IL-9054.K3 Rojo
- IL-9054.K7 Rojo cardenal
- IL-9054.O3 Blanco brillante
- IL-9069.BB Blanco mate
- IL-9069.MM Marron
- IL-9067.XX Cromado
- IL-9067.GG Oro
- IL-9067.RR Cobre

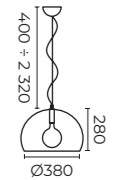

#### Kartell SMALL FL/Y

**IL-9054**  
Base E26  
25 W 120 V~  
Pza. caj. 1

**IL-9067**  
Base E26  
25 W 120 V~  
Pza. caj. 1

**IL-9069**  
Base E26  
25 W 120 V~  
Pza. caj. 1

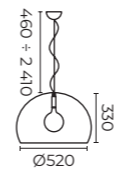

#### Kartell FL/Y

**IL-9031**  
Base E26  
25 W 120 V~  
Pza. caj. 1

**IL-9036**  
Base E26  
25 W 120 V~  
Pza. caj. 1

**IL-9039**  
Base E26  
25 W 120 V~  
Pza. caj. 1

- IL-9031.B4 Transparente
- IL-9031.K2 Azul nube
- IL-9031.K1 Azul petroleo
- IL-9031.K9 Verde salvia
- IL-9031.K6 Amarillo
- IL-9031.K4 Naranja
- IL-9031.K3 Rojo
- IL-9031.K7 Rojo cardenal
- IL-9031.K8 Verde botella
- IL-9031.K5 Verde azul
- IL-9031.O9 Negro brillante
- IL-9031.O3 Blanco brillante
- IL-9039.BB Blanco mate
- IL-9039.MM Marron
- IL-9036.XX Cromado
- IL-9036.GG Oro
- IL-9036.RR Cobre

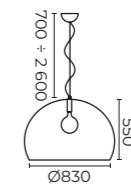

#### Kartell BIG FL/Y

**IL-9059**  
Base E26  
25 W 120 V~  
Pza. caj. 1

**IL-9098**  
Base E26  
25 W 120 V~  
Pza. caj. 1

- IL-9059.B4 Transparente
- IL-9059.K4 Naranja
- IL-9059.K9 Verde salvia
- IL-9098.BB Blanco mate
- IL-9098.MM Marron
- IL-9059.O3 Blanco Brillante



- \* Incluyen lámpara.
- \* No requieren driver.
- \* Fabricados en PMMA, operan lámpara LED tipo globo.
- \* Luminarios decorativos de suspensión con pantalla semiesférica translúcida.

Techo / Sobreponer / Suspender

## Luminarios decorativos |

fabricado en tecnopolímero termoplástico | fabricados en PMMA



IL-9271.B4  
Cristal



IL-9265.B4 (sus) Cristal  
IL-9469.XR (sus) Oro-Bronce-Cobre  
IL-9260.B4 (sus) Cristal  
IL-9464.XR (sus) Oro-Bronce-Cobre

**Kartell**

**BLOOM**

**IL-9271**  
Base G9  
6x33 W 120 V~  
Pza. caj. 1



**Kartell**

**BLOOM**

**IL-9260**  
Base G9  
6x33 W 120 V~  
Pza. caj. 1

**IL-9464**  
Base G9  
6x33 W 120 V~  
Pza. caj. 1

**IL-9265**  
Base G9  
6x33 W 120 V~  
Pza. caj. 1

**IL-9469**  
Base G9  
6x33 W 120 V~  
Pza. caj. 1

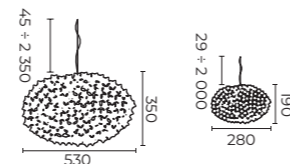

Techo / Suspender

## Luminarios decorativos |

fabricados en PMMA | fabricado en policarbonato



IL-9011.W1 Gris  
IL-9011.W3 Rojo  
IL-9011.W4 Naranja  
IL-9011.W5 Azul  
IL-9011.W7 Violeta  
IL-9011.W8 Verde  
IL-9014.XX Cromado  
IL-9014.GG Dorado

**Kartell**  
**LIGHT AIR**

**IL-9132**  
Base E14 (G45 LED)  
5 W 120 V~  
Pza. caj. 1

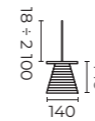

IL-9132.B4 Cristal  
IL-9132.Am Ambar

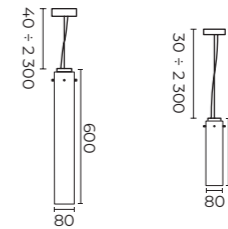
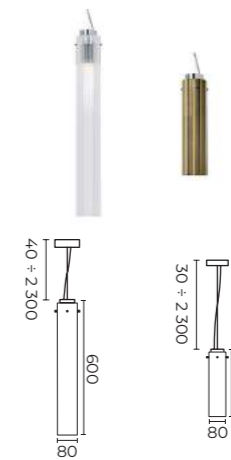

IL-9340.B4 Cristal (30cm)  
IL-9345.XX Cromado (30cm)  
IL-9345.GG Oro (30cm)  
IL-9350.B4 Cristal (60cm)  
IL-9355.XX Cromado (60cm)  
IL-9355.GG Oro (60cm)

**Kartell**

**EASY**

**IL-9011**  
Base E12  
28 W 120 V~  
Pza. caj. 1

**IL-9014**  
Base E12  
28 W 120 V~  
Pza. caj. 1

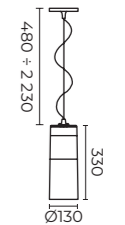

**Kartell**

**RIFLY**

**IL-9340**  
Base LED  
10 W 120 V~  
Pza. caj. 1

**IL-9345**  
Base LED  
10 W 120 V~  
Pza. caj. 1

**IL-9350**  
Base LED  
10 W 120 V~  
Pza. caj. 1

**IL-9355**  
Base LED  
10 W 120 V~  
Pza. caj. 1

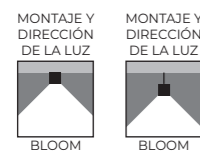

- \* Incluye lámpara.
- \* No requiere driver.
- \* Opera seis lámparas G9 base G9.
- \* Luminario con forma elíptica recubierto con flores de doble corola, fabricado en tecnopolímero.



- \* Incluye lámpara.
- \* No requiere driver.
- \* Opera lámpara halógena base E12 B.
- \* Luminario con forma cilíndrica, con acabado transparente arenado, fabricado en policarbonato.



# Luminarios decorativos |

fabricados en policarbonato



- IL-9081.B4  
Cristal
- IL-9081.P1  
Rosa
- IL-9081.P2  
Azul
- IL-9081.P4  
Amarillo
- IL-9081.P8  
Verde
- IL-9083.XX  
Cromada
- IL-9083.JJ  
Negro/Dorada
- IL-9083.KK  
Blanco/Dorado

## Kartell

### GÉ

#### IL-9083

Base E26  
70 W 120 V~  
Pza. caj. 1

#### IL-9081

Base E26  
70 W 120 V~  
Pza. caj. 1

- \* Fabricado en policarbonato.
- Opera lámpara halógena de base E26.
- \* No requiere driver.
- \* Incluye lámpara.

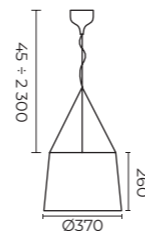

## Kartell

### BLOOM

#### IL-9251

Base G9  
9×33 W 120 V~  
Pza. caj. 1

- \* Fabricado en policarbonato. Opera nueve lámparas G9.
- \* No requiere driver.
- \* Incluye lámpara.

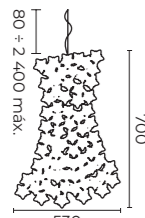

- IL-9051.B4  
Cristal

MONTAJE Y DIRECCIÓN DE LA LUZ



NEUTRA  
GÉ  
BLOOM  
É

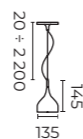

- IL-9041.B4(sus)  
Cristal
- IL-9041.P1(sus)  
Rosa
- IL-9041.P2(sus)  
Azul
- IL-9041.P4(sus)  
Amarillo
- IL-9041.P8(sus)  
Verde
- IL-9041.Q7(sus)  
Blanco
- IL-9041.Q8(sus)  
Negro

## Kartell

### É

#### IL-9041

Base E12 (B)  
28 W 120 V~  
Pza. caj. 1

- \* Fabricado en policarbonato plisado. Opera lámpara halógena base E12.
- \* No requiere driver.
- \* Incluye lámpara.



LUMINARIA: BOURGIE

## Luminarios decorativos |

fabricados en PMMA | fabricado en policarbonato

## Luminarios decorativos |

fabricado en ABS metalizado | fabricado en tecnopolímero termoplástico

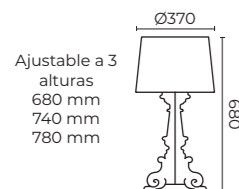

### Kartell

#### BOURGIE

##### IL-U9070

Base E12 (B)  
3x28 W Máx. 120 V~  
Pza. caj. 1

##### IL-U9072

Base E12 (B)  
3x28 W Máx. 120 V~  
Pza. caj. 1

##### IL-U9074

Base E12 (B)  
3x28 W Máx. 120 V~  
Pza. caj. 1

##### IL-U9076

Base E12 (B)  
3x28 W Máx. 120 V~  
Pza. caj. 1

\* Fabricado en policarbonato. Opera tres lámparas halógenas base. \* No requiere driver. \* Incluye lámpara.



### Kartell

#### CINDY

##### IL-9100

Base E26  
25 W 120 V~  
Pza. caj. 1

\* Fabricado en ABS metalizado. Opera lámpara CFL base E12. \* No requiere driver. \* Incluye lámpara.

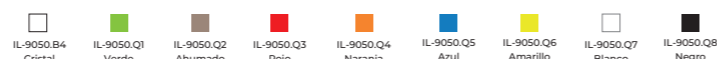
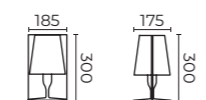
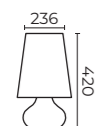

### Kartell

#### TAKE

##### IL-9050

Base E12 (B)  
28 W Máx. 120 V~  
Pza. caj. 1

\* Fabricado en policarbonato. Opera lámpara halógena base E12. \* No requiere driver. \* Incluye lámpara.

### Kartell

#### LIGHT-AIR

##### IL-9135

Base E14 (G45 LED)  
5 W 120 V~  
Pza. caj. 1

\* Fabricado en tecnopolímero termoplástico. Opera lámpara LED G45 base E14. No requiere driver. \* Incluye lámpara.

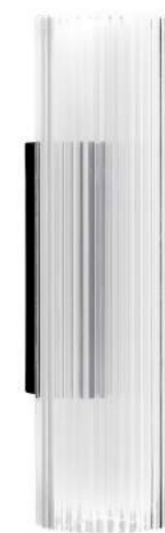
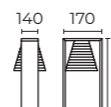

### Kartell

#### É

##### IL-9046

Base E12 (B)  
28 W 120 V~  
Pza. caj. 1

\* Fabricado en policarbonato plisado. Opera lámpara halógena base E12. \* No requiere driver. \* Incluye lámpara.



### Kartell

#### RIFLY

##### IL-9370

Base LED  
8.3 W 120 V~  
Pza. caj. 1

\* Luminario LED tipo arbotante. Fabricado en PMMA transparente. \* Incluye lámpara.



### Kartell

#### LIGHT AIR

##### IL-9121

Base E14 (G45 LED)  
5 W 120 V~  
Pza. caj. 1



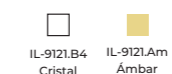
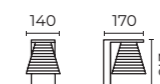









\* Fabricado en tecnopolímero termoplástico. Opera lámpara LED base E12. \* No requiere driver. \* Incluye lámpara.



## GLOSARIO |



## Glosario de símbolos |

ABS	ACRILONITRILO BUTADIENO ESTIRENO	Sensor integrado	
°	ÁNGULO	Soporta humedad	
cm	CENTIMETROS	Soporta polvo y agua	
~	CORRIENTE ALTERNA	Tecnología LED	<b>LED</b>
∅	DIÁMETRO	Tecnología solar	
Dimensión del corte recto	 xxx*xxx mm	XXX - XXX V~	VOLT
Dimensión del corte circular	 ∅xxx mm	XXX.X W	WATT
Dirección de la luz	<p>AJUSTABLE </p> <p>ASCENDENTE </p> <p>DESCENDENTE </p> <p>DIRECTA E INDIRECTA </p> <p>LATERAL </p>	Luminaria para Costa	
FP X.XX	FACTOR DE POTENCIA		
X XXX lm	LUMEN		
X XXX K	KELVIN		
Hz	HERTZ		
XX XXX h	HORAS		
IP XX	ÍNDICE DE PROTECCIÓN		
IRC≥XX	ÍNDICE DE REPRODUCCIÓN CROMÁTICA		
LED	LIGHT-EMITTING DIODE		
máx.	MÁXIMO		
PMMA	METACRILATO		
m	METRO		
mm	MILIMETROS		
Norma Oficial Mexicana			
PC	POLICARBONATO		
PP	POLIPROPILENO		
"	PULGADAS		

# ÍNDICE DE CÓDIGOS |



# Índice por código |

Código	Página	Código	Página	Código	Página
AC127-DC127.....	94	IL-U9076.....	146	PL-5205.A41.....	115
CD-0001.....	94	KIT-SUS.....	55	PL-5207.A27.....	115
CLIP-TL.....	94	KIT-SUS6C.....	55	PL-5207.A41.....	115
DL-4001.N.....	57	KITML-1220.N.....	96	PS-4301.N.....	119
DL-4001.N40.....	57	LED CAP.....	94	RL-3610.N30.....	122
DL-4001.S.....	57	MH-4239.BLED.....	87	RL-3610.N65.....	122
DL-4001.S40.....	57	MH-4239.LED.....	87	RL-36100.N30.....	123
EL-26100.B40.....	139	MH-4247.LED.....	87	RL-36100.N65.....	123
EL-26100.B57.....	139	MH-4248.LED.....	87	RL-36200.N30.....	124
EL-26146.B40.....	139	MH-4253.A.....	131	RL-36200.N65.....	124
EL-26146.B57.....	139	MH-6135.....	132	RL-3630.N30.....	122
EL-2635.B40.....	139	ML-6136.....	132	RL-3630.N65.....	122
EL-2635.B57.....	139	ML-0563.BC30KIT.....	94	RL-3650.N30.....	123
EL-2650.B40.....	139	ML-0563.BF30KIT.....	94	RL-3650.N65.....	123
EL-2650.B57.....	139	ML-1601.EMER.....	99	SE-2101.B.....	103
EL-2670.B40.....	139	ML-1703.EMER.....	99	SE-2102.B.....	103
EL-2670.B57.....	139	ML-2300.B.....	88	SE-2103.B.....	103
EL-4501.C.....	131	ML-2300.N.....	88	SE-7000.....	104
EL-4502.C.....	131	ML-2301.B.....	88	SE-7002.....	105
EL-7130.PC.....	138	ML-2301.N.....	88	SE-7004.....	106
FC-2104.S.....	103	ML-2302.B.....	88	SL-1602.EMER.....	99
FC-2104.SAcc.....	103	ML-2302.N.....	88	TF-7125.B30.....	81
FL-10A19.KIT30.....	109	ML-2303.B.....	89	TF-7125.B40.....	81
FL-10A19.KIT65.....	109	ML-2303.N.....	89	TF-7125.B65.....	81
FL-10GU10.527.....	110	ML-2304.B.....	134	TF-7125.BEMER.....	81
FL-10GU10.530.....	110	ML-2304.N.....	134	TF-7125.BSENS.....	81
FL-10GU10.565.....	110	ML-2305.BSENS.....	89	TF-7125.BSENSDIM.....	81
FL-10MR16.530.....	110	ML-2305.NSENS.....	89	TF-7149.B30.....	81
FL-10MR16.540.....	110	ML-2701.BCSE.....	95	TF-7149.B40.....	81
FL-10T8.18MV.....	109	ML-3603.N27LEC.....	93	TF-7149.B65.....	81
FL-10T8.18MV60.....	109	ML-3701.A.....	127	TF-7149.BEMER.....	81
H-5205.....	115	ML-3702.A.....	127	TF-7149.BSENS.....	81
H-5207.....	115	ML-3706.G.....	130	TF-7149.BSENSDIM.....	81
H-5408.....	115	ML-3727.G.....	130	TF-7225.B30.....	81
IL-9011.....	143	ML-4601.B.....	91	TF-7225.B3SENS.....	81
IL-9014.....	143	ML-4601.N.....	91	TF-7225.B3SENSDIM.....	81
IL-9030.....	141	ML-4602.B.....	91	TF-7225.B40.....	81
IL-9031.....	141	ML-4602.N.....	91	TF-7225.B65.....	81
IL-9036.....	141	ML-4603.B.....	91	TF-7225.BEMER.....	81
IL-9039.....	141	ML-4603.N.....	91	TF-7249.B30.....	81
IL-9041.....	144	ML-4605.B.....	92	TF-7249.B40.....	81
IL-9046.....	147	ML-4605.N.....	92	TF-7249.B65.....	81
IL-9050.....	146	ML-4606.B.....	92	TF-7249.BEMER.....	81
IL-9051.....	144	ML-4606.B.....	92	TF-7249.BSENS.....	81
IL-9054.....	141	ML-7114.N.....	135	TF-7249.BSENSDIM.....	81
IL-9059.....	141	ML-7114.NEMER.....	135	TF-8125.EMR30.....	75
IL-9067.....	141	ML-7114.NSENS.....	135	TF-8125.EMR40.....	75
IL-9069.....	141	ML-7114.NSENSDIM.....	135	TF-8125.EMR65.....	75
IL-9081.....	144	MS-3104.N.....	129	TF-8125.NEMR30.....	75
IL-9083.....	144	MS-3105.N.....	129	TF-8125.NEMR40.....	75
IL-9098.....	141	MS-3106.N.....	129	TF-8125.NEMR65.....	75
IL-9100.....	146	PL-2303.S.....	116	TF-8125.NSOR30.....	76
IL-9121.....	147	PL-2501.N.....	137	TF-8125.NSOR40.....	76
IL-9135.....	146	PL-2501.N65.....	137	TF-8125.NSOR65.....	76
IL-9260.....	142	PL-2501.P.....	137	TF-8125.NSUS30.....	77
IL-9265.....	142	PL-2501.P65.....	137	TF-8125.NSUS40.....	77
IL-9271.....	142	PL-2502.N26.....	137	TF-8125.NSUS65.....	77
IL-9340.....	143	PL-2502.N36.....	137	TF-8125.SOR30.....	76
IL-9345.....	143	PL-2502.P26.....	137	TF-8125.SOR40.....	76
IL-9350.....	143	PL-2502.P36.....	137	TF-8125.SOR65.....	76
IL-9355.....	143	PL-4503.C.....	120	TF-8125.SUS30.....	77
IL-9370.....	147	PL-4504.C.....	120	TF-8125.SUS40.....	77
IL-9464.....	142	PL-4505.C.....	120	TF-8125.SUS65.....	77
IL-9469.....	142	PL-4506.C.....	120	TF-8150.EMR30.....	75
IL-U9070.....	146	PL-4801.B.....	93	TF-8150.EMR40.....	75
IL-U9072.....	146	PL-5003.....	116	TF-8150.EMR65.....	75
IL-U9074.....	146	PL-5205.A27.....	115	TF-8150.NEMR30.....	75



# Índice por código |

Código	Página
TL-8132.NSOR30	71
TL-8132.NSOR40	71
TL-8132.NSUS30	71
TL-8132.NSUS40	71
TL-8132.SOR30	71
TL-8132.SOR40	71
TL-8132.SUS30	71
TL-8132.SUS40	71
TL-8156.EMR30	66
TL-8156.EMR40	66
TL-8156.NEMR30	66
TL-8156.NEMR40	66
TL-8156.NSOR30	67
TL-8156.NSOR40	67
TL-8156.NSUS30	67
TL-8156.NSUS40	67
TL-8156.SOR30	67
TL-8156.SOR40	67
TL-8156.SUS30	67
TL-8156.SUS40	67
TL-8164.EMR30	70
TL-8164.EMR40	70
TL-8164.NEMR30	70
TL-8164.NEMR40	70
TL-8164.NSOR30	71
TL-8164.NSOR40	71
TL-8164.NSUS30	71
TL-8164.NSUS40	71
TL-8164.SOR30	71
TL-8164.SOR40	71
TL-8164.SUS30	71
TL-8164.SUS40	71
TL-8180.SR	84
TL-8190.SR	83
TL-8224.SR	84
TL-8418.SR40	83
TL-8418.SR65	83
TL-8618.SR	83
TR-2401	53
TR-2402	53
TR-2403	53
TR-2404	53
VT-1904.B	101
VT-1906.B	101
VT-1914.B	101



PROYECTO: Patio Toluca  
LUMINARIAS: SUPER-LINE

# CATÁLOGO

Temazcal No. 21-B, Colonia La Loma  
Tlalnepantla de Baz, Estado de México CP. 54060 / Tel. 01(55) 5355 9797

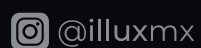

[www.illux.com.mx](http://www.illux.com.mx)